

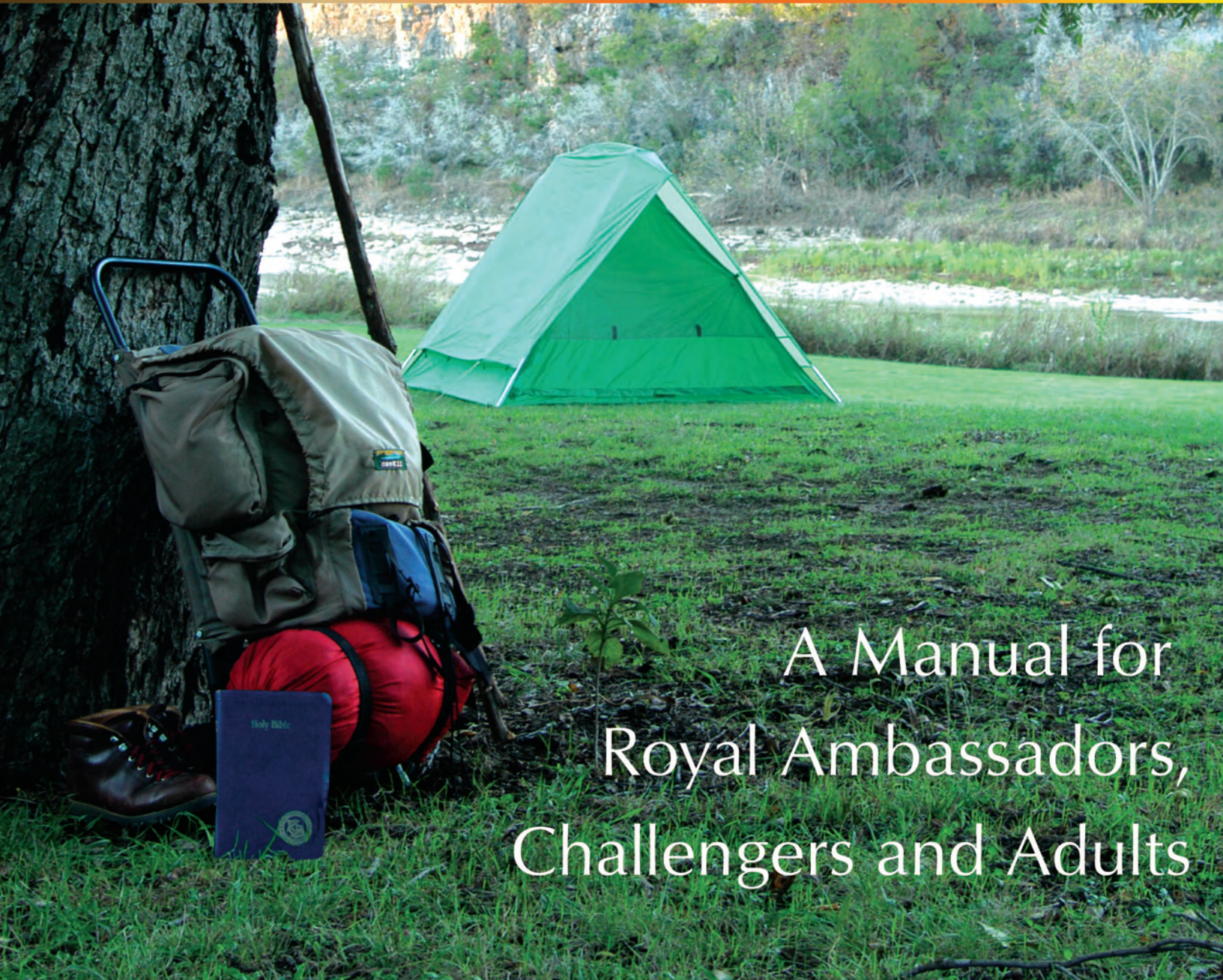

Campcraft

Outdoor Living Skills



A Manual for
Royal Ambassadors,
Challengers and Adults

How to become a Christian:

A Christian is a follower of Jesus Christ. A Christian has a growing relationship with Jesus Christ, tries to obey Him in all things, and draws on His strength to help with problems. God made us for Himself and our souls are restless until they find rest in Him. The answer to your search is accepting Jesus Christ as the Lord and Savior of your life. To become a Christian, you need to know these basic facts from the Bible:

1. God loves you. "For God loved the world in this way: He gave His One and Only Son, so that everyone who believes in Him will not perish but have eternal life." (John 3:16) Because of God's love for all, He desires to have a relationship with you.
2. You are a sinner. "We all went astray like sheep; we all have turned to our own way; and the Lord has punished Him for the iniquity of us all." (Isaiah 53:6) "There is no one righteous, not even one." (Romans 3:10) To sin is to "miss the mark." To sin is to disobey God and choose to go your own way and do your own thing instead of being obedient.
3. Sin separates you from God. "For all have sinned and fall short of the glory of God." (Romans 3:23) God cannot allow sin into His heaven. Sin separates us from God.
4. You can't save yourself. "For by grace you are saved through faith, and this is not from yourselves; it is God's gift – not from works, so that no one can boast." (Ephesians 2:8-9) People often think that they can earn their way to heaven or if they are "good" enough they will make it. There is nothing you can do to earn God's salvation.
5. God sent His Son Jesus. "But God proves His own love for us in that while we were still sinners Christ died for us!" (Romans 5:8) The death of Jesus on the cross bridges the gap between you and God. Jesus died for your sins, making it possible to restore a right relationship with God.
6. You can receive Jesus Christ through faith. "If you confess with your mouth, "Jesus is Lord," and believe in your heart that God raised him from the dead, you will be saved. With the heart one believes, resulting in righteousness and with the mouth one confesses, resulting in salvation." (Romans 10:9-10) To have faith is to trust in Christ and what He has done for you. You must give Christ full control of your life.
7. Through prayer you can trust in Jesus Christ. "Seek the Lord while He may be found; call to Him while He is near. Let the wicked one abandon his way, and the sinful one his thoughts; let him return to the Lord, so He may have compassion on him, and to our God, for He will freely forgive." (Isaiah 55:6-7) Pray this prayer:

"Dear Lord Jesus, I believe that You died on the cross for my sins and that You arose from the grave. I now ask You to forgive me of my sins and to save me.
Amen."

Accepting Christ is the beginning. After accepting Him, be obedient by following Christ in baptism and by uniting with a church. When you do, you will find that your life truly does have purpose and meaning. Talk with another Christian about your decision for Christ. There is more information on the inside back cover to help you tell others about your relationship with Jesus Christ.

Campcraft

Outdoor Living Skills

*A Manual For Royal Ambassadors,
Challengers and Adults*

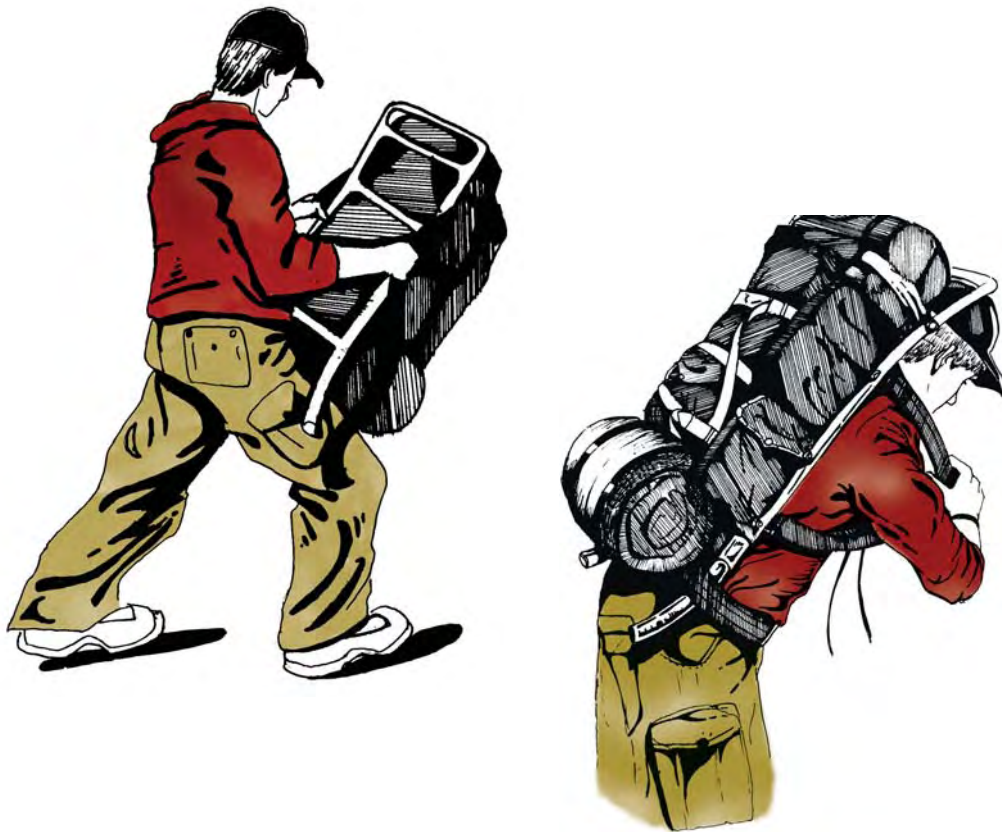

Campcraft - Outdoor Living Skills includes material from:

Royal Ambassador Campcraft
By Frank Black
Copyright 1960, Brotherhood Commission

Royal Ambassador Campcraft (Revised)
By Frank Black and Charles Doggett
Copyright 1972, Brotherhood Commission

Royal Ambassador Campcraft (Revised)
Compiled by Bob Banks
Copyright 1982, Brotherhood Commission

Brotherhood Campcraft
Compiled by Brotherhood Commission
Copyright 1987, Brotherhood Commission

Brotherhood Campcraft (Revised)
Compiled by Brotherhood Commission
Copyright 1991, Brotherhood Commission

Copyright © 2006 by Texas Baptist Men. Southern Baptist churches and associations may use contents to help involve men, young men and boys in missions. Others should request permission from Texas Baptist Men.

Scripture quotations are taken from the Holman Christian Standard Bible® copyright © 1999, 2000, 2002, 2003 by Holman Bible Publishers. Used by permission.

Table of Contents

Introduction	1
Chapter 1 Trip Planning	15
Chapter 2 Equipment & Shelter.....	25
Chapter 3 Rope Craft	43
Chapter 4 Tool Craft.....	71
Chapter 5 Fire Craft	85
Chapter 6 Cooking	99
Chapter 7 First Aid	121
Chapter 8 Safety & Sanitation	133
Chapter 9 Map & Compass	147
Chapter 10 Nature	163
Chapter 11 Conservation.....	183
Chapter 12 Fun & Worship.....	191
Appendix	203
Index	235



Preface

Campcraft – Outdoor Living Skills is a compilation of skills from years of Royal Ambassador camping experience and ideas shared by many people. Frank Black was the author of the first Royal Ambassador Campcraft book (1960) and trained adult leaders in outdoor living skills. His life exemplified and sought to instill in others a high standard of work in the teaching of Campcraft and in the conducting of camping programs. He was also instrumental in the initiation and development of the Adult Campcraft Training Program.

It is impossible to measure the contributions that Frank Black and others have made in training people in outdoor living skills and through them the influencing of others for Christ.

Special appreciation is also expressed to the following:

Gunnar Peterson (deceased), director of Outdoor Education (1960), Chicago City Missionary Society of the Congregational Churches, for his help in developing the Royal Ambassador Campcraft program; Plymouth Cordage Company for permission to use suggestions from “Useful Knots and How to Tie Them”; E.F. Larsen of Silva, Inc., for his help in developing the chapter on map and compass and permission to use suggestions from Silva booklets; Catherine T. Hammett for helpful criticism and suggestions; George Euting for many helpful suggestions;

1972 edition, Charles Doggett, with assistance from state directors and their associates;

1981 edition, the 1980-81 National Royal Ambassador Campcraft Committee: Lloyd Jackson, Paul McCullough, Eddie Pettit, Cal Jones, Rusty Griffin, Bob Banks, Frank Black, and Jimmie Gresham;

1987 edition, Tim Seanor for editing the Brotherhood Campcraft and Roy White and Herschel Wells for artistic design;

2006 Campcraft - Outdoor Living Skills, the Texas Baptist Men Campcraft Committee: Larry Blanchard, Don Roman, Herb Weaver, Murrie Wainscott, Milton Schmidt, Rooster Smith, John Travis Smith, Warren Hart, Bob Mayfield, Steve Darilek and Keith Mack for their contributions, revisions and additions. Illustrations by Jake Griggs.



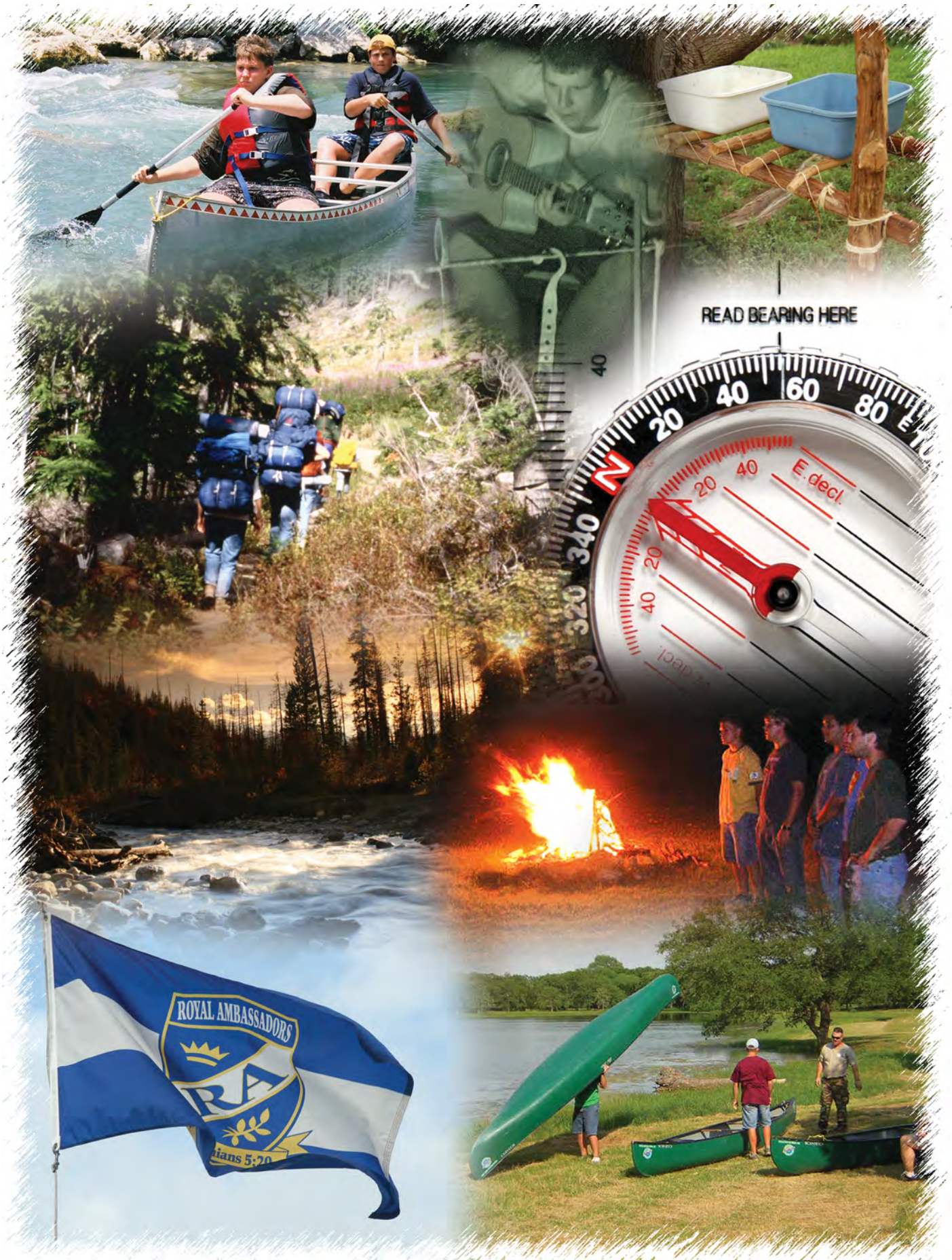

INTRODUCTION



- ✓ The Bible and Outdoor Living
- ✓ God's World
- ✓ Purpose of Campcraft
- ✓ Royal Ambassador Campcraft
- ✓ Challenger Campcraft
- ✓ Adult Campcraft Training
- ✓ Stewardship of God's World
- ✓ Spiritual Markers
- ✓ Spiritual Applications
- ✓ Missions Applications

The Bible and Outdoor Living

There are many reasons why people who love God often love life outdoors. God made His natural world beautiful. God's people as a nation once lived outdoors. The pages of the Old Testament are filled with pictures of nature.

In the early pages of the Bible, Jabal is declared the father of such as dwell in tents (Genesis 4:20). There were tent cities before walled cities. Tents made from animal skins were the only types of homes that many of our Bible heroes ever knew. Jacob was said to be a plain man dwelling in tents (Genesis 25:27). Food was cooked on open fires. Elijah, the rugged champion of the mountains and plains, was awakened from his sleep under a juniper tree by an angel and showed bread and meat baking on a fire (1 Kings 19:5-8).



Nature was a challenge. Amos, the prophet, talked of snares for birds (Amos 3:5). Isaiah, another prophet, knew of the terrific heat of the sun and told of sunstroke (Isaiah 49:10). A discerner of the heavens knew that when the wind came from the north, the rain would soon be gone (Proverbs 25:23). Benaiah was noted for his valor because he killed a lion in a pit on a snowy day (1 Chronicles 11:22). When Hiram, the king of Tyre, wanted to send Solomon his cedar and fir trees, he made rafts and floated them on the open sea (1 Kings 5:9).

Numerous references are made to the use of bows and arrows. Jonathan, a beloved friend of David, used a boy to bring back the arrows that he shot into the sky (1 Samuel 20:36). Those who went into the woods and forests lived by sight, sounds, and instinct. Gideon, a judge of his people, reduced his army from 10,000 to 300 by bringing them to a stream of water and observing each one as he drank. The men who lay down and drank directly with their mouths from the stream were rejected, but those who cupped their hands and pressed the water to their mouths were accepted. Those who lifted the water to their mouths were free to observe their surroundings while drinking. They were alert and alive to the wilderness. The men who fell upon their faces to drink could well have been at the mercy of wild animals or a dangerous enemy.

The beauty of nature is reflected in the Old Testament. David wrote, "When I observe Your heavens, the work of Your fingers, the moon and the stars, which You set in place, what is man..." (Psalm 8:3-4a).

Nothing went unnoticed. The blade of grass, the ant, the quail, the rocks, the snakes, the long night, the glorious sunrise, and the cry of the wild, are all in the imagery of the Old Testament.

As a boy, Jesus lived in Galilee. A more beautiful country could scarcely be imagined. The landscape was free, fresh, and bracing. Lake Gennesaret, arched by a deep blue sky, was (and is) beautiful.

Living amid such scenery, Jesus probably was easily led by the Spirit of God to meditate and pray. In manhood it was the custom of Jesus to go apart into the mountains and pray through the night. (Luke 5:16) Even before His death on the cross, Jesus spent His last evening praying in the garden.



Jesus was a man of the outdoors. He observed nature and used it frequently in His teachings. Jesus talked of the birds of the air, the grass in the field, and the wind in the trees.

There is little question that most of the time Jesus slept, cooked, and ate His food outdoors. Once, when a lawyer approached Jesus and said that he would follow Him no matter where He would go, Jesus replied by telling something of how He lived. "Foxes have dens and birds of the sky have nests, but the Son of Man has no place to lay His head." (Matthew 8:20).

Jesus loved nature, for it was His Father's world. When He was born, God guided men from the East to His birthplace by a star. He was baptized in a river, He preached from the mountain side, He drank water from a well. He slept peacefully in a boat during a severe storm.

Frequently, Jesus quoted from the book of Psalms, and no doubt His heart rejoiced in the grandeur of Psalm 24: "The earth and everything in it, the world and its inhabitants, belong to the LORD " (Psalm 24:1).

This is God's world. What a privilege and joy it is to live for God in God's world.

God's World

Do you ever dream about getting outdoors - a trip to the woods, a place on a lake, maybe a canoe trip down the river?



Sounds like fun, doesn't it? And it is, BUT did you ever stop to think of all the things that can take away the fun? No one likes to have his trip ruined because of blistered feet caused by wearing the wrong shoes or a sunburned back from failing to follow good health practices.

This will not happen if training is completed and proper plans are made ahead of time. You can have fun if you learn outdoor living skills.



Purpose of Campcraft

Campcraft - Outdoor Living Skills is committed to the holistic growth of men, young men, and boys through:

- Structured camping experiences that call the individual to discover his importance and interrelation with the created universe.
- Programming which enables the individual to enlarge his self-esteem while learning to respect the dignity of others.
- Incorporating missions-ministry, education, and practice into the organizing of our schedules.
- Encouraging individuals to enjoy and test their physical, mental and spiritual development.
- Supporting and complementing the local church missions education program.



The purpose of Campcraft is to help you take care of yourself and others comfortably and safely on hikes and camps in order to enjoy these experiences. It also is to help you become more aware of God and what He has done in creation and your stewardship of the natural world. Campcraft will help you to not only have fun but to also grow as an individual and as an active member of your church. Doing all this will require planning, learning outdoor living skills, and practicing safety. Campcraft - Outdoor Living Skills will guide you in structured camping experiences to learn the basics of living outdoors.

Royal Ambassador Campcraft

The Royal Ambassador Campcraft levels with patches help you learn planning, outdoor living skills, and safety. Discoverer patches (1-3) are for Lads in grades one through three respectively and are designed to introduce younger Royal Ambassadors to day camping experiences. The Hiker, Camper and Woodsman patches are for Crusaders in grades four through six and are designed to introduce older Royal Ambassadors to the progressive levels of Campcraft skills and outdoor experiences. Crusaders must complete the Hiker level before advancing to the Camper level and then to the Woodsman level. The requirements for all of these levels begin on page 205 in the Appendix section.



Once you have earned these patches you can wear them on the back of your Royal Ambassador vest. To order Royal Ambassador patches, contact the national WMU at (800) 968-7301 or www.wmystore.net.

Royal Ambassador Patches

The specific requirements for each of these levels are located in the Appendix section beginning on page 205.

Royal Ambassadors	Discoverer 1	Discoverer 2	Discoverer 3	Hiker	Camper	Woodsmen
Trip Planning	Picnic	Outdoor Trip Local Trip	Park Electric Co. Work Place	1 mile hike Log When lost Evaluate	Hikes or Campout Log Evaluate	2-1 Nighters Log Evaluate
Equipment and Shelter	Make Bed	Fun Shelter Draw Pictures	Emergency Kit Shelter Pictures Clothing	Clothing	Equipment Bedding Pitch Tent	Equipment Tent Site Pitch Tent Make Equipment Group Equipment
Rope Craft	Shoelaces	Unravel Rope Uses of Rope	5 Ropes History Care of Rope	Overhand Knot Square Knot Clove Hitch	5 Knots Whip Rope	2 Types Lashing 3 Kinds of Rope
Tool Craft	Flashlight	Hammer Canteen	Can Opener Tool Apron Shovel	Pocket Knife Proper Use	Bow Saw	Use of Tools Sheath Knife Cooking Device
Fire Craft	Fire Dept.	Fire Dept. Burnables	Camp Fires Fire Starter Use of Fire	Matches Fire Site 3 Minute Fire Clean-up	Fire Safety 2 Types of Fires Put out/Clean up	Trench Fire Clean Site
Cooking	Meal	Grocery List Menu	Utensils Salad Trail Snack	2 Items	2 Types Balanced Meals	Balanced Meal
First Aid	Bandage	Emergency Number Emergency Plan	Poster First Aid Kit Ice Pack	Burn, Cut, Bruise	Group First Aid Kit	List Items Poison Plant Aid
Safety and Sanitation	Clothes	Seatbelt Escape Route	Drugs Bicycle Toiletry Kit	Hike Safely Latrine Good Practices	Cleanliness Garbage Latrine Good Practices	Latrine When Lost Poison Plants Good Practices
Map and Compass	Home Address	Draw Map Lost	Direction Map Compass	Parts of Compass Compass Directions Trail Signs	Length of Pace Compass Course	Follow Map Make Map Stars
Nature	Nature Walk	Tree Bark Pet Rock	Feeder Wind Weather	2 Harmful Plants 2 Harmful Animals	2 Harmful Insects 2 Helpful Insects	Read Book Nature Collection
Conservation	Lights	Litter Water	Recycle Collection Tree	Pledge Good Practices	Learn Project Explain Project	Project Know Agencies
Fun and Worship	Drawings	Prayer Game	Lord's Prayer Songs 23 rd Psalm	Game/Song Missionary Story	Hiking Song Missions Story	Outdoor Game Ceremony/ Activity

Challenger Campcraft

The Challenger Campcraft levels with patches are for young men who desire to explore God's creation and learn planning, outdoor living skills and safety. The Pathfinder level is the beginning point for all Challengers and introduces them to the basic levels of camping experiences. Once a young man has completed the Pathfinder level, he can advance to the intermediate level of Adventurer. After completing the Adventurer level, a young man can begin working on the advanced Campcraft levels. The Backpacker, Trip Camper and Primitive Camper levels are the advanced Campcraft levels and can be earned in any order. The specific requirements for each of these levels is located in the Appendix section beginning on page 211.



Once you have earned these Campcraft patches you can wear them on the back of your Challengers jacket. To order Challenger patches, contact Texas Baptist Men at (214) 381-2800 or www.texasbaptistmen.org.

Challenger Campcraft Patches

The specific requirements for each of these levels are located in the Appendix section beginning on page 211.

Challengers	Pathfinder	Adventurer	Back Packer	Trip Camper	Primitive Camper
Trip Planning	5 Mile Hike Cookout 2 Overnights When Lost Journal Evaluation Spiritual Markers Mission Project	2 Two Nights Make Plans Journal Evaluate Spiritual Application Mission Project	3 Day Trip Evaluate Spiritual Application Mission Application	4 Day Trip Shared Duty Conditioning Temporary Camp Evaluate Spiritual Application Mission Application	4 Day Primitive Camp Plan Evaluate Spiritual Application Mission Application
Equipment and Shelter	Clothing Equipment Bedding Tent Site Make Equipment Group Equipment Psalm 58:8 Mission Application	Clothing-Gear Shelter Group Gear Isaiah 25:4 Construct Shelter	Personal List Proper Packing Temporary Shelter Clothing Spiritual Application Mission Application	Waterproofing 4 Tents Packing Care for Mode Other Group Spiritual Application Mission Application	Clothing Bed Roll Shelter Spiritual Application Mission Application
Rope Craft	Whip Rope Overhand Square Knot Clove Hitch 5 Knots Two Lashings Three Ropes William Carey Mission Application	Camp Fixture Two Knots Share Christ Help Others	4 Knots Spiritual Application Mission Application	2 Splices Coil Rope 4 Knots Spiritual Application Mission Application	Use of Ropes 6 Knots Use Knots 4 Lashings Spiritual Application Mission Application
Tool Craft	Pocket Knife Bow Saw Select Tools Sheath Knife Cooking Device Use of Knife Mission Application	Care for Axe Camping Tools 2 Kings 6:1-6 Minister	Proper Tools Spiritual Application Mission Application	Tools Storage Spiritual Application Mission Application	Use Knife & Axe Tools Know Tools Make Something Tin Cans Spiritual Application Mission Application
Fire Craft	Fire Safety Fire Triangle Matches Fire Site 3 Minute Fire Two Types Fires Alternate Fire Camp Stove Put Out, Clean Up Hebrews 12 Matthew 5:6	Build Fire Protect Fuel Damp Wood Fire Site Light Source Fire – Purity Emergency Lights	Fire Regulations Fire in Wet Spiritual Application Mission Application	Review Emergency Fires Safety Procedures Spiritual Application Mission Application	Fire Regulations Gather Fuel Light Source Spiritual Application Mission Application
Cooking	Complete Meal Two Types Cooking 2 Peter 1:5-9 Evaluate	Two Types Cooking Three Complete Meals Camp Stoves “Bread of Life” Prepare Meal	3 Day Meals New Method Backpack Stove Spiritual Application Mission Application	Plan Menus Prepare Meals Practice Shop Spiritual Application Mission Application	Plan Meals Cook Off the Land Spiritual Application Mission Application

Challenger Campcraft Patches

The specific requirements for each of these levels are located in the Appendix section beginning on page 211.

Challengers	Pathfinder	Adventurer	Back Packer	Trip Camper	Primitive Camper
First Aid	Personal First Aid Kit Group First Aid Kit Burn, Cut, Bruise, Bite Poisonous Plants Luke 10:30-37 Mission Project	First Aid Treatments Update Personal Kit Jeremiah 8:22 Mission Project	Standard First Aid Injuries First Aid Kits Spiritual Application Mission Application	Standard First Aid Injuries First Aid Kits Spiritual Application Mission Application	Standard First Aid Injuries First Aid Kits Spiritual Application Mission Application
Safety and Sanitation	Hike Safety Latrines Garbage Cleanliness Safety Practices Duet. 23:12-14 Biblical Examples	Waste Water Food Storage Good Practices Spiritual Application Mission Project	Travel Plan Health Guides Water Purification Proper Methods Spiritual Application Mission Application	Safety Rules Rules of Road Trip Plans When Lost Personal Health Resources Spiritual Application Mission Application	Water Purification Safe Methods Latrine Garbage Spiritual Application Mission Application
Map and Compass	Use Compass Trail Signs Know Pace Compass Course Follow Map Make Map Stars Psalm 8:3-4 Thoughts	Cross Country Make Map Find Direction Way, Truth, Life Prayer	Topo Map Map and Compass Triangulation Spiritual Application Mission Application	Judgments Reference Point Plot Route Map Use Spiritual Application Mission Application	Compass Use Make Map Spiritual Application Mission Application
Nature	4 Insects 2 Plants 2 Animals Read Book Nature Collection Psalm 8 Thoughts	New Collection 5 Trees-Plants 5 animals-insects Job 38 Christ's Applications	Three Animals Weather Conditions Spiritual Application Mission Application	10 Trees 5 Constellations & North Star Nature Trail Weather Forecast Log Spiritual Application Mission Application	10 Trees Wildlife 4 Weather Signs Clouds Winds Spiritual Application Mission Application
Conservation	Conservation Pledge Good Practices Visit Project Personal Project Luke 12:41-48 Thoughts	Group Project Spiritual Application Mission Project	Minimum Impact Good Techniques Discussion Spiritual Application Mission Application	Camping Spots Project Spiritual Application Mission Application	Practice Causes of Fires Ecology Spiritual Application Mission Application
Fun and Worship	Game or Song Mission Story Ceremony or Activity Quiet Time Share	Camp Fun Camp Worship Reflect Prayer	Devotion Game Spiritual Application Mission Application	Schedule Spiritual Application Mission Application	Recreation Quiet Times Spiritual Application Mission Application

Adult Campcraft

The Adult Campcraft training introduces adults to the basic, intermediate and advanced levels of Campcraft skills in order to increase their personal knowledge, abilities and comfort level with experiences in outdoor living. These courses emphasize using teaching methods and spiritual applications to assist Royal Ambassadors and Challengers in fulfilling each of their Campcraft levels. For more information concerning the Adult Campcraft training, contact Texas Baptist Men at (214) 381-2800 or www.texasbaptistmen.org.



Stewardship of God's World

Have you gone to a park or campsite and found bottles, paper, cans, and other litter on the grounds? Have you seen what would have been a beautiful river or stream except there was trash all around? Have you been out in the woods and noticed where someone damaged a tree or built a big campfire and failed to clean up the site?

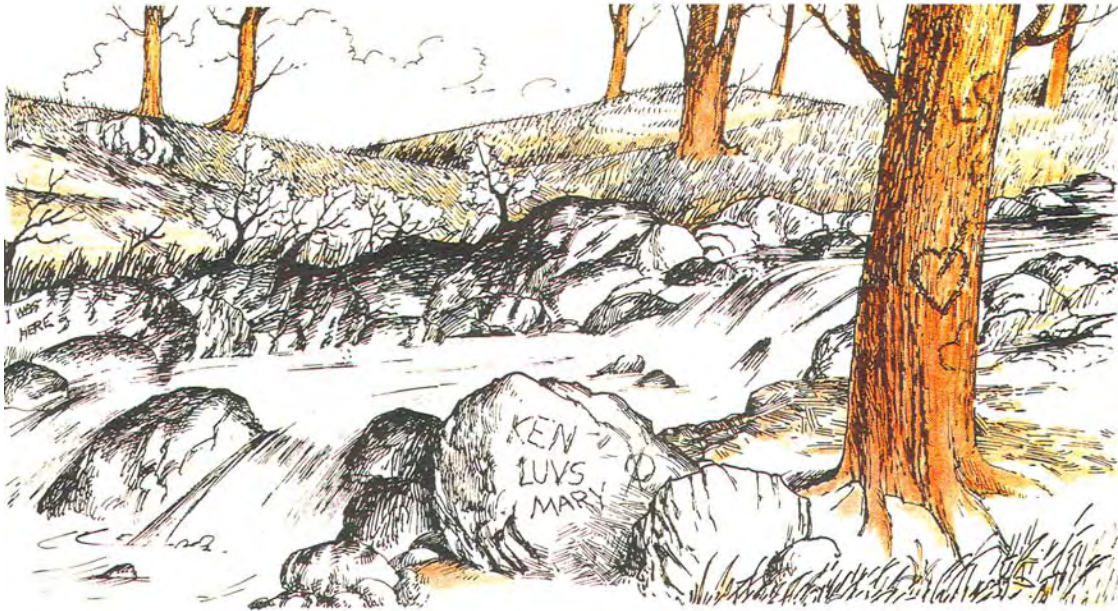

Such disregard for the beauty and conservation of the outdoors is not representative of the best kind of camping. Campcraft and our use of the outdoors should demonstrate the best stewardship of what God has placed in our care. We are not to litter. When we wisely use the woods, the streams and all other natural resources, we are being good Christians as well as good citizens.

There are good stewardship practices that all of us should follow. For example, in building a fire, use as little wood as necessary to get the job done; use dead or downed wood if possible. Recognize that in some areas of the country, it is not permissible to build wood fires. Know fire regulations for your camping area and how to control fires.

Consider the environment and try to live in an area without disturbing it more than necessary. "Leave no trace" camping will leave a low impact on the camping site. Restore the area to its natural state as much as you can when you leave.



As a steward of God's world, try to improve it, not just keep it. Work on conservation projects as an individual or as a group. Protect the soil and water. There are many projects that will help preserve the outdoors. Select those that you can best do and which are most needed in your area. There are many other good practices which should be followed in your Campcraft activities. Become aware of these and always practice good outdoor manners.

Finally, one other way you can help in conserving the outdoors is to recognize that many of the skills can be learned and practiced in places other than out in a camp or on the trail. Going on a trip is primarily a time for demonstration of skills learned and enjoyment of hiking and camping.

Spiritual Markers

Spiritual markers are used to serve as reference points so that individuals can evaluate where they have been, where they are, and the direction they need to proceed. The purpose of the Spiritual Markers worksheet is to assist Challengers in evaluating their lives and relationships with Christ and encourage them in making any necessary adjustments to accomplish the purpose that God has for their lives. A Spiritual Marker worksheet is located in the Appendix section.

Spiritual Applications



The disciples encountered unique experiences as the Master teacher, Jesus, used several methods and examples found in nature to communicate spiritual truths and principles to them. Often, He would make comparisons between common everyday items and spiritual truths, such as faith the size of a mustard seed being able to move mountains (Matthew 17:20). Campcraft skills can be applied to help explain or help remember spiritual truths. One example is comparing sin in one's life to a splinter in a finger. If not removed, the splinter will cause pain in the hand like sin will cause pain in our lives. These spiritual applications are intended to communicate simple spiritual truths so that others may develop a greater relationship with their Creator.

Throughout this manual, references to spiritual truths and examples of spiritual applications will be made. You are encouraged to develop your own spiritual applications from your outdoor experiences in order to share spiritual truths with others. The advancement requirements for Challengers will have them stop and think about what spiritual applications can be drawn from the campcraft skills being learned.



Missions Applications



Bob Dixon, a Royal Ambassador Campcraft Instructor, was the first person called to help organize a response to Hurricane Beulah in 1967. Bob was returning from a weekend Campcraft training session with a load of campcraft gear. He cooked meals on the back of his stationwagon using Buddy Burners. As responses to disasters continued, Bob called upon other Campcraft Instructors to help. These men possessed the knowledge and experience to use their outdoor living skills to help people who were affected by natural disasters. Southern Baptist Disaster Relief was thus born from Campcraft.

Testimonies have been shared from missionaries who have utilized their outdoor living skills, learned as RA's, to properly pack for extended trips into the jungles or construct temporary shelters that would be used in missions efforts. Challengers will be encouraged to stop and reflect upon how these campcraft skills can be used in missions endeavors. Take time to reflect upon the outdoor living skills and ask God to reveal to you how you could use campcraft in God's mission of reconciling the world unto Himself.

"Therefore if anyone is in Christ, there is a new creation; old things have passed away, and look, new things have come. Now everything is from God, who reconciled us to Himself through Christ and gave us the ministry of reconciliation: that is, in Christ, God was reconciling the world to Himself, not counting their trespasses against them, and He has committed the message of reconciliation to us. Therefore, we are ambassadors for Christ; certain that God is appealing through us, we plead on Christ's behalf, "Be reconciled to God."'" (2 Corinthians 5:17-20)



TRIP PLANNING

1



- ✓ Planning and Conducting a Group Outing
- ✓ Leadership Responsibilities
- ✓ Selecting a Campsite
- ✓ Taking the Next Step
- ✓ Tips on Trip Planning
- ✓ Trip Planning - Biking
- ✓ Trip Planning - Canoeing
- ✓ Evaluating the Trip

- Notes -

*"The fear of the LORD is the beginning of knowledge; fools despise wisdom and instruction."
(Proverbs 1:7)*

*"For I know the plans I have for you' this is the LORD's declaration 'plans for your welfare, not for disaster, to give you a future and a hope. You will call to Me and come and pray to Me, and I will listen to you. You will seek Me and find Me when you search for Me with all your heart. I will be found by you' the LORD's declaration 'and I will restore your fortunes and gather you from all the nations and places where I banished you' the LORD's declaration."
(Jeremiah 29:11-14)*

Planning and Conducting a Group Outing

Proper planning and preparation will insure a safe and enjoyable trip. A leader that involves the group in the planning process will best use the complete camping experience as a training opportunity. The group members will not only learn more, but will take more ownership in the outing. Depending upon the skill level of the group members, the leader might need to participate as actively as offering options and helping make decisions or as little as simply recording the group's decisions. Ultimately, the responsibility for a successful trip depends upon the leader and the preparations that are made.



Group Discussion and Decision Making

Purpose of going. Always have a purpose for going and repeat it often in order to keep focused on it during your planning process.

When to go. Plan well in advance. Select a date for the outing and mark it on the calendar.

Where to go. Have two or three places that you are familiar with, and let the group decide which place to go. After these decisions have been made, it is time to plan.



Let's Make Some Plans

First pray that God will guide you and draw everyone closer to Him on the trip. If your group is small and it is not desirable to divide into planning groups, then planning can be done as one group. Planning as a single group may take longer and may not involve all of the boys as well as if they had been divided into smaller groups. If your group is large, then divide into smaller groups. The following should be discussed:

- Food
- Equipment
- Clothing
- Games or activities
- Travel plans



Food Planning Group makes the following decisions:

- Number of meals.
- Menu for each meal.
- Cost of each meal.
- Who will purchase the food.
- Cooking gear needed for each meal.
- Who will bring what cooking equipment.



- Notes -

*"Commit your activities to the LORD and your plans will be achieved."
(Proverbs 16:3)*

*"Plans fail when there is no counsel, but with many advisers they succeed."
(Proverbs 15:22)*

Various natural disasters occur in different parts of the world. We should be aware of these potential disasters and plan to help people in need by being trained and prepared to respond. RAs and Challengers can pray for and collect money that will be used for disaster relief.

- Notes -

Think about a friend who does not attend a church whom you might invite to go to your RA or Challenger campout.

Equipment Group needs to decide:

- If tents will be needed. If so, how many.
- Which hand tools will be needed (rake, shovel, limb loppers, broom, hammer, stakes, bow saw, etc.).
- If fire starting equipment will be needed.
- What fire extinguishing equipment (bucket for water, fire extinguisher, etc.) will be needed.
- Who secures the equipment.



“Therefore, brothers, by the mercies of God, I urge you to present your bodies as a living sacrifice, holy and pleasing to God; this is your spiritual worship. Do not be conformed to this age, but be transformed by the renewing of your mind, so that you may discern what is the good, pleasing, and perfect will of God.”
(Romans 12:1-2)

Clothing Group must consider:

- How many days you will be gone.
- The type of activities you will be doing.
- The season and probable weather conditions (summer, winter, spring, fall).
- The types of plants or other vegetation expected during the trip.
- Preparing a clothing checklist for each camper.



Games or Activities Group needs to decide:

- The purpose of each activity.
- The devotional times and a leader for each. Use as many people as possible.
- Who can provide musical talent in the group.
- Games that are not normally played at home.
- How to adapt the rules so that everyone can participate.
- What props or equipment are needed to play games.

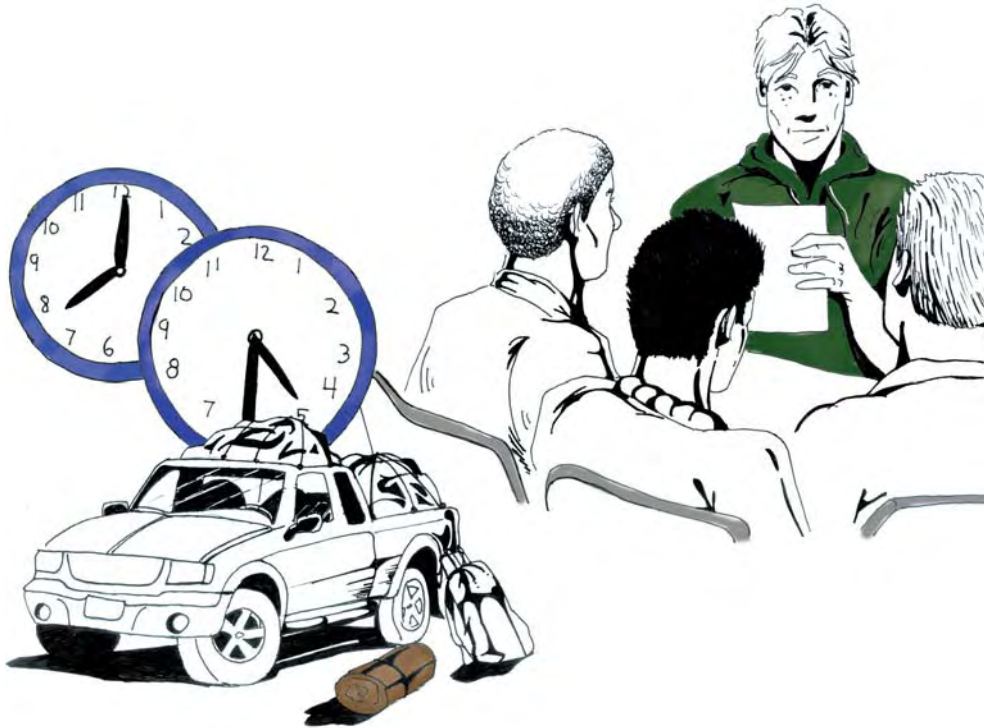

*“Many plans are in a man’s heart, but the LORD’s decree will prevail.”
(Proverbs 19:21)*

*“How can a young man keep his way pure? By keeping Your word. I have sought You with all my heart; don’t let me wonder from Your commands. I have treasured Your word in my heart so that I might not sin against You.”
(Psalm 119:9-11)*

Travel Group, working closely with the leader, must decide:

- The length of the trip. (Remember, for a one night trip, it is not a good idea for a sponsor, who may have worked all day and then participated late in the day, to have to drive home the next day. Consider staying two days, to allow for more rest on the second night.)
- The mode of transportation (bus, van, hiking, bicycles, etc.).
- The cost of the transportation chosen.
- If a driver is needed. If so, secure one and secure a backup, just in case.
- The departure time.
- The estimated return time.
- How and when medical releases and information will be obtained.
- The special needs of any participants.
- The itinerary. Leave one with several people for emergency purposes.

Finalize Trip Plans

After completing their work, all the groups need to come together to discuss what each has decided, making sure everyone has their concerns addressed. Set a cost for the trip and make financial arrangements.

- Notes -

"The LORD spoke with Moses face to face, just as a man speaks with his friend. Then Moses would return to the camp, but his assistant, the young man Joshua son of Nun, would not leave the inside of the tent. Moses said to the LORD, 'Look, you have said to me, "Lead these people up," but You have not let me know whom you will send with me. You said, "I know you by name, and have also found favor in My sight." Now if I have indeed found favor in Your sight, please teach me Your ways, and I will know You and find favor in Your sight.'" (Exodus 33:11-13)

"All the ways of a man seem right to him, but the LORD evaluates the motives." (Proverbs 21:2)

Leadership Responsibilities

One of the primary concerns of the leader is for the health and safety of each member of the group. Listed below are items that each leader should consider before an outing. Carry this information with you on the trip.

- Seek God's leadership in all matters.
- Secure sufficient help (one adult per 6 children - minimum of two leaders).
- Have someone trained in first aid and take a group first aid kit.
- Obtain medical releases and medical information forms for everyone.
- Get insurance coverage information.
- Identify location of nearest medical facilities.
- Know the special needs of campers (medical and social).
- Obtain emergency contact numbers (parents and agencies).
- Do not mix two unknowns. Be familiar with the capabilities of your group or be familiar with the camping area.
- File several copies of your trip plans with several responsible adults and parents. Trip plans should include your departure and estimated return times.
- Remain flexible and willing to adjust plans as necessary.
- Communicate any changes in travel plans to the appropriate people.
- Keep a positive attitude. It is contagious with campers!



Selecting a Campsite

If you will be packing in to a campsite, stop early before everyone is tired and worn out. You will need time to find a good campsite. Selecting a good campsite will include considering whether the site will be used for a base camp (several days) or a trail camp. You will need to remember the following guidelines:

- Camps should be kept away from the trail and kept out of sight so that other campers and hikers will not be disturbed. Campsites should be at least 150 feet from a natural water source, if possible. Keep away from shorelines or waterfalls; a campsite near these areas decreases the beauty for everyone else.
- Find a smooth area with a gentle incline to carry rain water away from the site. Look for a place that if rain occurs, it will not run in and flood your campsite. The area should be clear of rocks and other debris. (Rocks are not very comfortable under a sleeping bag.)
- Stay away from dry riverbeds and areas with signs of previous flooding, swamp plants and dangerous places under overhangs.
- Watch for signs of bad weather. Consider the prevailing winds, lightning strikes, and escape routes in case of a fire.
- Cooking on an open fire takes a lot of wood; try to use downed (fallen) wood or deadwood instead of green wood.
- Locate and make latrines a safe distance from camp and away from any water source (a minimum of 150 feet where possible). Keep the latrine area clean by disposing of toilet paper and human waste by covering with soil.
- Always use the “Good Gardener” concept. This practice promotes “leave it better than you found it” so that the next campers think they are the first ones to ever be there.

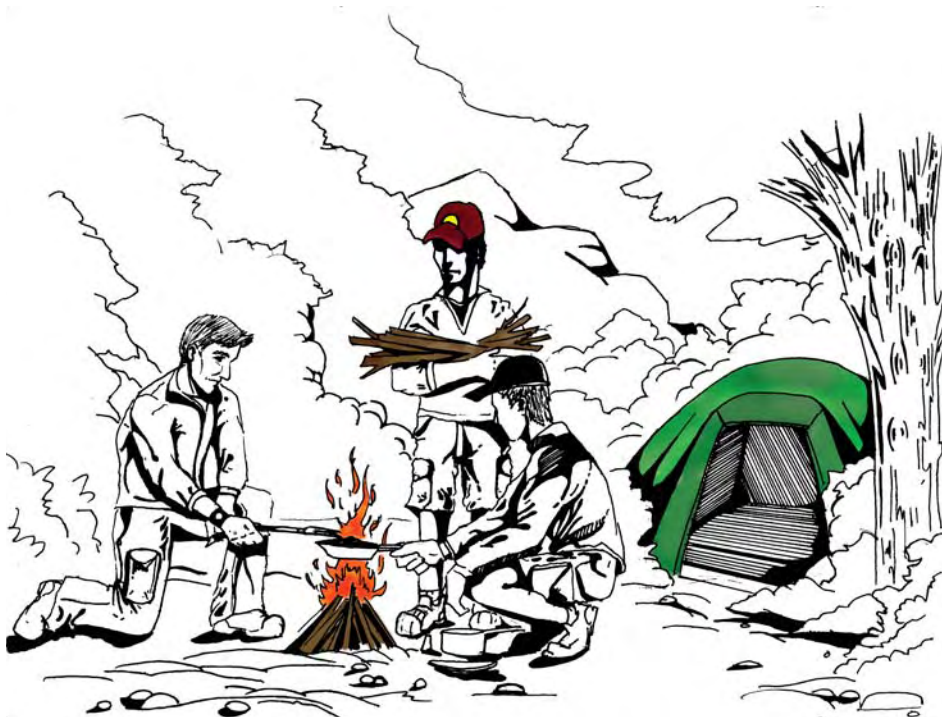

- Notes -

Build your life upon a solid foundation. Strive to learn and follow Jesus' teaching.

“Listen, Israel: The LORD our God, The LORD is One. Love the LORD your God with all your heart, with all your strength. These words that I am giving you today are to be in your heart. Repeat them to your children. Talk about them when you sit in your house and when you walk along the road, when you lie down and when you get up.” (Deuteronomy 6:4-7)

- Notes -

*"Call to Me and I will answer you and tell you great and wondrous things you do not know."
(Jeremiah 33:3)*

Taking the Next Step

Begin with simple trip plans until you have developed the outdoor living skills necessary for more advanced outdoor adventures.

Hiking - Simple hikes to earn campcraft patches and to explore God's creation.

Camping - Requires more planning, skills, and equipment. Start with a one-night campout and then expand to multi-nights as skills grow.

Backpacking - Taking outdoor living skills to the next level by learning to live with the items that can be carried in a backpack.

Trip Camping - Extended trips into the outdoors by utilizing various types of transportation.

Primitive Camping - The ultimate in your camping experiences. A combination of all of the above skills and many of the activities can be used to experience the thrill of living off the land.



Tips on Trip Planning

- When you have decided on a camping location, get information from resources located near the area. There may be places of interest nearby that can be enjoyed.
- Determine the emergency services available to your camping area.
- Carry a charged cell phone for emergency use.
- A trip log (journal) may be purchased or created. Use your journal to record the positive experiences, those needing improvement and observations made in nature. The journal is a good resource for planning future trips as well as making a scrapbook for recording names and addresses.
- A camping library is inexpensive and useful. Books on first aid, nature, and cooking are useful. Books on general campcraft will cover items that will prove to be beneficial in a camp.
- Now that we have the trip planned, the next important thing is to help each Royal Ambassador and Challenger to learn the outdoor living skills needed for a successful outdoor experience.

*"This is what the LORD says:
Stand by the roadways
and look. Ask about the
ancient paths: Which is
the way to what is good?
Then take it and find rest
for yourselves."
(Jeremiah 6:16)*

Trip Planning – Biking

- Notes -

Have lots of advanced planning and training before engaging in a biking trip. Plan to use back roads (not frequently used) and biking trails. A prepared leader will travel the planned route in advance before taking his group. Careful consideration should be taken for the following: food, clothing, equipment and spare parts, tools, and medical needs. Make sure that all bicycles are road-worthy. Advanced training for a bike trip includes taking short trips with the group beforehand to build up their stamina.



Overall Suggestions for the Trip

- Don't overextend the group!
- When you start getting tired, stop before fatigue sets in. Exhausted bikers are more likely to have accidents.
- Start the trip on a full stomach, munch on snacks and drink liquids often to maintain a high energy level.
- Watch for signs of heat exhaustion! Be sure to use a hat or cap to protect from the sun.
- Wear layers of clothing so that some clothes can be taken off as the trip progresses.

Equipment that Might be Needed

- Helmet
- Map, compass, GPS
- First Aid kit
- Tire repair kit
- Air pump, extra tube
- Screw driver and wrench
- Cell phone
- Poncho or raincoat
- Flashlight
- Thermal Blanket (emergency blanket)



- Notes -

*“But you will receive power when the Holy Spirit has come upon you, and you will be My witnesses in Jerusalem, in all Judea and Samaria, and to the ends of the earth.”
(Acts 1:8)*

Plan with your RA or Challenger group a mission project that would include using the skills you have learned in trip planning.

Your life can be compared to a journal with each day beginning with a blank page. Daily reflect upon the day’s activities and ask the Lord to help you evaluate your life.

Trip Planning – Canoeing

Canoe trips can be taken on large lakes and rivers. Individual and group preparation is essential to ensure a safe and enjoyable experience. It is highly recommended that all participants be physically qualified and trained in canoeing and in the type of camping experience needed for the trip. As with other types of trip camping, it is good for beginners to experience shorter or easier trips before taking longer or more difficult ones. Everyone should be proficient and comfortable at swimming. Life jackets must be worn at all times while in or near a body of water. To keep essential items dry, store them in a watertight container (5 gallon paint bucket, dry bag, etc.). Plan to tie down everything in the canoe.



Evaluation of the Trip

Upon the group’s return from any camping or outdoor experience, sit down and have a round table discussion on the good points and things about the trip that need improvement next time. Having the campers keep a journal (log) of their activities while on the trip will greatly aid in evaluating the trip.



*“Plans fail when there is no counsel, but with many advisers they succeed.”
(Proverbs 15:22)*

EQUIPMENT & SHELTER

2



- ✓ Personal Equipment and Clothing
- ✓ Group Equipment
- ✓ Making an Envelope Sleeping Bag
- ✓ Selecting a Sleeping Bag
- ✓ Tents
- ✓ Pitching a Tent
- ✓ Tent Camping in the Winter
- ✓ Caring for a Tent
- ✓ Other Types of Shelters
- ✓ Backpacks
- ✓ Using a Pack
- ✓ Canoe Equipment
- ✓ Tips on Equipment and Shelter

Personal Equipment and Clothing

All hikers and campers have their reasons for liking particular items of equipment or clothing. A piece of equipment one person thinks is necessary, another person might leave at home. Each person, depending upon the time of year and type of outdoor activity, may require or want different equipment and gear.

Instead of making another expert list of clothing and equipment, a list of generally needed and used items is given. The following grouping is a convenient way to organize the items you would carry on a two-night or longer trip.

Experienced campers often use ditty bags and plastic zip closure bags to keep items dry, separated, and organized in their pack.



Remember: You pack it in and you pack it out! The weight of your final pack is important.

Personal Equipment

- Bible and study materials
- Pencil and paper
- Personal First Aid Kit
- Matches and/or butane lighter
- Pocketknife
- 50-foot ¼ inch nylon rope
- Map and compass
- GPS (optional)
- Flashlight and spare batteries
- Toilet paper
- Trowel (plastic garden trowel)
- Gloves (leather)
- Bandanas
- Whistle and signal mirror
- Hiking boots
- One pair of comfortable shoes to wear around camp
- Sleeping bag, pad and ground cloth
- Tent



What piece of equipment could be used to describe an attribute of God's character?

"Your word is a lamp for my feet and a light on my path." (Psalm 119:105)



Personal Hygiene

- Biodegradable soap
- Toothpaste
- Toothbrush
- Lip balm
- Insect repellent
- Comb
- Metal mirror
- Wet wipes (alcohol free)
- Essential personal medications
- Small bottle of powder

Repair Essentials

- Extra shoelaces
- 50 ft. of 1/8 nylon rope
- Large safety pins
- Needle, thread and buttons
- Matches and/or lighter
- Small roll of duct tape
- Flashlight bulb and batteries
- Extra zip closure bags



“But seek first the kingdom of God and His righteousness, and all these things will be provided for you. Therefore, don’t worry about tomorrow, because tomorrow will worry about itself. Each day has enough trouble of its own.” (Matthew 6:33-34)



Personal Kitchen Items

- Spoon, fork and knife
- Plastic or metal cup (sierra type)
- Plastic or metal plate or bowl
- Mess kit (1 and 2 qt. pots, skillet and pot gripper)
- Canteen or water bottle(s) (2 qt. minimum)

Gear is like the things God has given us: our talents, health, wealth, love, eyes, heart, hands and feet. We should be good stewards of the things God has given to us and offer them back to God in service.

Optional Items

- Watch
- Sunglasses
- Camera and film
- Binoculars
- Nature books
- Campcraft manual
- Swimsuit
- Air pillow



- Notes -

*"I greatly rejoice in the LORD, I exult in my God; for He has clothed me with the garments of salvation and wrapped me in a robe of righteousness."
(Isaiah 61:10)*

Clothing

Select clothing based upon the type of activity and the weather you expect. Always be prepared for the worst conditions. The conditions of the terrain might determine the type of pants and shoes or boots. Cotton is very comfortable when dry, but is heavy and will not provide warmth when wet. Clothing made of wool or synthetics will provide warmth when wet and dries much quicker than cotton.

Warm weather conditions. Wear a hat and light clothing that covers as much of your skin as possible to prevent sunburn and heat exhaustion .

Cold weather conditions. Clothing should be worn in layers to offer better insulation. As the weather warms up, you can shed a layer at a time to stay comfortable. Layers should include the following:

- A vapor transmission layer worn next to the body to wick moisture away from the skin while providing warmth.
- An insulating layer that is heavier or bulkier to hold warm air next to your body.
- A protective layer to protect the inner layers from water and wind.

Summer Clothing

- Full brim soft hat or ball cap
- Tee shirts
- Lightweight long sleeve shirt
- Long pants (jeans or slacks)
- Hiking shorts
- Underwear
- Socks (cotton or wool)
- Hiking boots or shoes
- Camp shoes (tennis shoes)
- Windbreaker jacket with hood
- Rain gear (poncho or rain suit)



Winter Clothing

- Head cover (toboggan, balaclava)
- Insulated windbreaker jacket with hood
- Tee shirts
- Long sleeve shirts (wool or flannel)
- Long pants (jeans or wool pants)
- Long johns (polypropylene, wool or silk)
- Liner socks (polypropylene, nylon or silk)
- Outer socks (heavy wool)
- Hiking boots (high top)
- Gaiters (to keep snow out of boots)
- Camp shoes (tennis shoes)
- Gloves
- Rain gear (poncho or rain suit)



Group Equipment (For 12 people)

- Notes -

For a Drive-To Base Camp

One cooking set containing:

- 1 - 8 qt. pot
- 1 - 4 qt. pot
- 1 - 2 qt. pot
- 1 - 2 qt. coffee pot
- 1 - 12 inch fry pan w/cover
- 12 plates
- 12 cups
- 1 - 12 inch Dutch oven



Cleanup kit containing:

- 3 - 2 gal. pails
- 2 scouring pads
- 2 heavy duty 30 gal. trash bags
- Bio-degradable detergent

Fire building equipment including:

- 2 - 20 inch bow saws
- 2 - shovels
- 1 - single bit axe (optional)
- 1 - heavy duty wire grill (optional)
- 1 - griddle (optional)



Cooking tool kit containing:

- 1 butcher knife
- 1 large fork and spoon
- 1 ladle
- 1 pancake turner
- 1 potato peeler
- 1 can opener
- 1 measuring cup set
- 1 sugar canister
- 1 set of salt and pepper shakers
- 1 box matches (strike anywhere and weather proof)
- 2 sets of pot holders and/or heavy duty leather gloves
- 1 roll of heavy duty aluminum foil
- 2 rolls of paper towels
- 2 - 5 gal. water cans
- 1 group first aid kit (mandatory)



Is there gear or equipment items your family might have that you could give to someone so that they could enjoy an outdoor experience?

"The LORD is my shepherd; there is nothing I lack. He lets me lie down in green pastures; He leads me beside quiet waters. He renews my life; He leads me along the right paths for His name's sake. Even when I go through the darkest valley, I fear no danger, for You are with me; Your rod and Your staff — they comfort me. You prepare a table before me in the presence of my enemies; You anoint my head with oil; my cup overflows. Only goodness and faithful love will pursue me all the days of my life, and I will dwell in the house of the LORD as long as I live."
(Psalm 23)

Making an Envelope Sleeping Bag

Using One Blanket

Place your ground cloth down first. **1** Spread your blanket and fold two-thirds of it over as shown. **2** Now fold the other third under as shown. **3** Now fold the ends under. **4** Pin it in place with large blanket pins and you have a snug, comfortable bed.

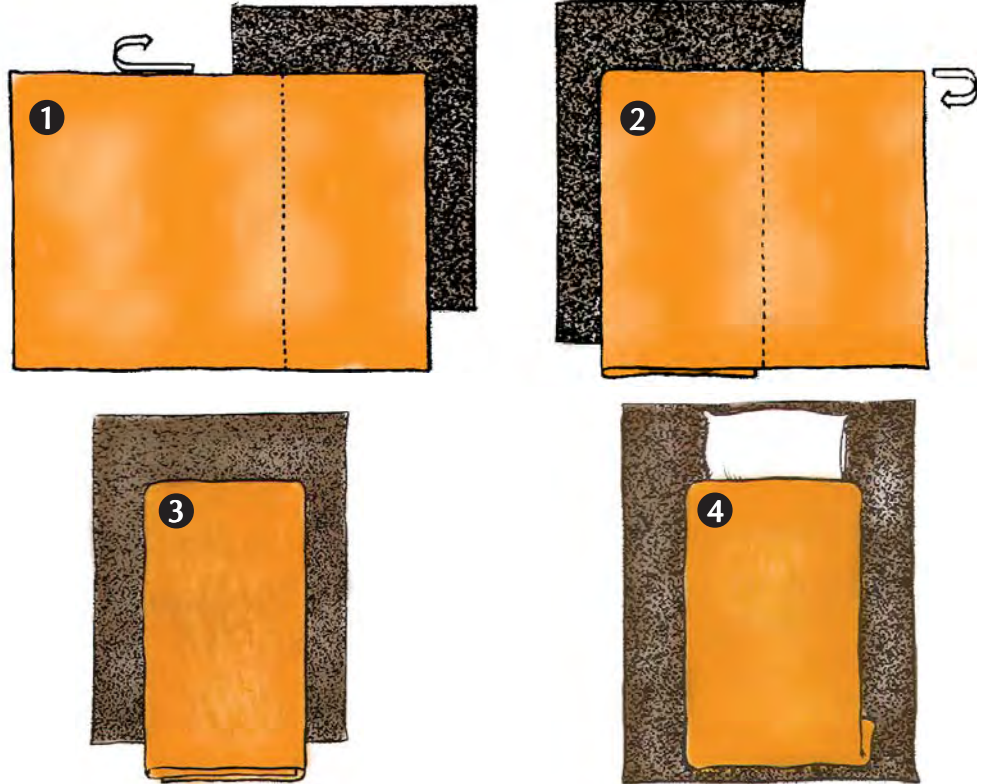

Using Two Blankets

Follow the same procedure as with one blanket. **1** Place the second blanket in the middle of the first blanket. **2** Fold the left and right sides over and pin.

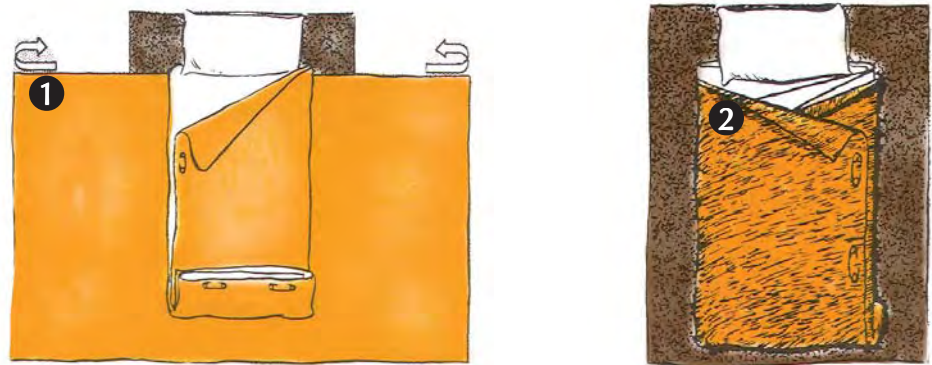

For added comfort. Bring an extra bed sack and fill it with grass, leaves and/or pine needles. *Remember,* when you break camp, spread the grass and leaves to make it appear as if an elk had slept there.

Selecting A Sleeping Bag

A sleeping bag may be one of the most important pieces of equipment in which you will invest. You will need to try to determine the time(s) of the year and location(s) where you will be camping to determine what weight of bag you will purchase. Light, efficient sleeping bags can be moderately priced but may not provide enough warmth for the temperatures you will encounter. If you are planning to camp in extreme cold, the proper bag could be considerably more expensive. With these thoughts in mind, purchase a sleeping bag only after careful study and consideration.

Shape

Mummy or contoured bags conserve heat and reduce weight, but some people do not care for the space restriction and thus prefer the more common rectangular bags.



Filling

The best fillings are either a synthetic material or down. Try to stay away from the cheaper, cotton filled bags because they tend to lump up, giving you little warmth in very cold weather.

Outer Covering

A water repellent outer cover (not waterproof) is recommended.

Closure

A full-length heavy-duty double zipper will allow you to close or open your bag as temperatures dictate. In extreme cold, a mummy bag with a drawstring allows you to draw in the hood and enclose all of your body except your face. With any type of bag, you can cover your head with a cap, hat, toboggan, balaclava, etc. and help control the loss of body heat.

Weight

The lighter weight bag will lighten your load. A down filled bag is the lightest, but when wet, is heavy and slow to dry. Synthetic filled is a bit heavier but dries much faster.

Ground Cloth

A recommended item. A heavy plastic sheet will serve well and serves two purposes:

- To keep the bottom of your sleeping bag dry and clean.
- To add another layer of insulation between you and the ground.

- Notes -

God provides resources when you do God's work, God's way, and give God the glory.

- Notes -

*"I would hurry to my shelter from the raging wind and the storm."
(Psalm 55:8)*

God's love provides a shelter for our lives. It covers us like nothing else can; it shields us, upholds us, blesses us, teaches and nourishes us. This is more than a sufficient shelter.

Tents

Every tent has its purpose and value. There is really no such thing as an "all-purpose" tent, even though certain models are more popular, and each person, camp, group or family will choose a favorite.

The Fabric

Cotton is a good material for tents because it breathes or allows air to circulate while turning away the wildest winds and rains. It comes in duck, drill, twill, poplin and canvas. Duck costs more, weighs more and is recommended only for wall tents and tarps.



Nylon is lighter than cotton in weight. When used in conjunction with the rain fly, campers will stay drier due to air being allowed to circulate through the tent. This is known as a double wall tent. The tent walls are made of breathable nylon and the floor is made of waterproof nylon or reinforced plastic, extending up the walls 4-6 inches from the floor. The rain fly (the outer cover), made of waterproof nylon, covers the tent. The open space between the two layers allows air to circulate between them. The tent should be vented at the top to allow for the reduction of the moisture buildup inside the tent.



Types of Tents

Solo Tents come in 1 and 2 person sizes and are usually referred to as “A” frame tents (“pup” tents) or free standing tents.



“A” frame



Free Standing Tent

Dome Tents come in a variety of sizes and shapes, from 2-4 person up to large family sizes. Many use freestanding frames while others require that the rain fly be tied to stakes.



Wall Tents are usually made of heavy canvas. These tents are 3-4 person and larger in size. Often used for base camps that can be reached by vehicles. They allow extra room for the use of cots and other bulky items.



- Notes -

*“For we know that if our earthly house, a tent, is destroyed, we have a building from God, a house not made with hands, eternal in the heavens.”
(2 Corinthians 5:1)*

- Notes -

"Why do you call Me 'Lord, Lord,' and don't do the things I say? I will show you what someone is like who comes to Me, hears My words, and acts on them: He is like a man building a house, who dug deep and laid the foundation on the rock. When the flood came, the river crashed against that house and couldn't shake it, because it was well built. But the one who hears and does not act is like a man who built a house on the ground without a foundation. The river crashed against it, and immediately it collapsed. And the destruction of that house was great!" (Luke 6:46-49)

Where we pitch our tent is important if it is going to stand the storms of this world. Just as important is where we choose to pitch our life. The foundation you chose will make all the difference when the storms of life come. The right place to pitch your tent for life is on Jesus Christ our solid foundation.

Pitching A Tent

Choose a site as flat and clean as possible, not in a drainage area and away from trails and water supply. Pitch the tent where water will drain away from the tent. Look for standing dead trees and trees with dead limbs that might fall in a heavy wind. Set your tent out of the range of these trees and limbs.



Tent Camping in the Winter

Winter camping can be fun and adventurous. Preparation for the camping experience and protection from the cold are the primary considerations. While you can use the same tents in the winter as in other seasons, tents on snow may require a different set up. Pick a spot clear of snow and ice covered tree branches. Pitch your tent with the door facing away from the prevailing winds to protect the door from drifting snow.



Start by preparing a good base for your tent. Pack down the snow by stomping with your feet in an area larger than your tent. Some campers prefer to clear out the snow down to the bare ground, but this can be extremely difficult and time consuming in deep snow. Anchoring your tent may be a problem because you cannot use regular tent pegs that work in other seasons of the year. You can use “deadman” anchors, as illustrated. Anything you can use to bury in the snow may serve as an anchor.

Aluminum or plastic pegs with “T” cross sections can be used. Whatever you use, do not tie tent ropes directly to the deadman anchor

because a hard freeze may prevent you from releasing the rope. A loop made of metal, old rope or rag can serve as a connector between the tent rope and the deadman anchor.



Caring for a Tent

A good tent, properly cared for, can last for many years of service. Caring for a tent includes living in it, storing it, repairing it and waterproofing it.

Living in a Tent

Observe the following to prevent leaks or damage to a tent:

- Do not have fires, lighted candles, or stoves inside or near the tent.
- Do not store or use sharp items inside the tent.
- Do not pin things to the top or sides.
- Do not touch the insides when wet.
- Do not spray insect repellent inside the tent.
- Keep the tent’s vents open as much as possible to minimize condensation.

Repairing a Tent

Repair kits, grommet kits, sewing awl and threads are readily available. Always make repairs as soon as possible after a rip or tear.

Storing a Tent

70 to 95 percent of a tent’s life is spent in storage. The most important factor for storage is the tent being completely dry. A wet tent stored will mildew and possibly rot. A tent should be thoroughly cleaned, repaired and stored in a cool, dry, well-ventilated place.

A tent can be compared to a church; it shelters its occupants, keeping them dry, warm and shaded providing a secluded place for worship. The tent cords are like the outreach programs of the church. The tent stakes are like the church workers who faithfully serve and anchor the church. The tent poles are like those who with their prayers, gifts and offerings, witnessing and visitation help to provide support for the church.

- Notes -

*"For You have been a stronghold for the poor, a stronghold for the humble person in his distress, a refuge from the rain, a shade from the heat. When the breath of the violent is like rain against a wall."
(Isaiah 25:4)*

Other Types of Shelters

Rain Fly or Tarps. A rain fly made of waterproof nylon or a tarp made of waterproof plastic material can make a good shelter. A popular size of 10 ft. x 12 ft. is large enough to cover 2-3 campers. Tie a rope between 2 trees for support as a ridge. Fold the fly or tarp over the rope in a "tent" shape or tie it to the rope and stretch tarp out as a "lean-to".



Sides can be attached by rope or twine to stakes, logs, or rocks. If the weather is fair, pitch the ridge and sides high or if rain is expected, pitch them low.



Poncho. A poncho can likewise be used in several different ways for a quick emergency shelter.

Canoe Shelters. Turn a canoe on its side as the shelter ridge. Stretch a rain fly or tarp out from the canoe and stake down.

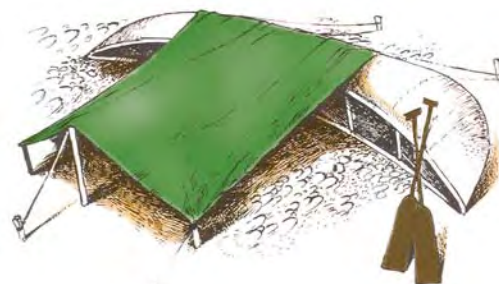

Lean-To. A lean-to type shelter can be made using natural materials. Lash a shelter frame on one side using tree limbs. Cover the frame with leafy tree branches or brush to make a roof for the lean-to.



Backpacks

- Notes -

A hiker or backpacker must carry the essential equipment, yet he soon learns to lighten the load every way possible. Factors to consider when selecting a pack include the cost, the frequency of use, the appropriate load and the specific person. A good rule of thumb to use is to pack no more than 1/3 your body weight for pack weight.

“And my God will supply all your needs according to His riches in Christ Jesus.” (Philippians 4:19)

Day Packs

A day pack is a small pack or rucksack for carrying essentials for a day hike where you are not planning to stay overnight. These packs do not have a frame but may have a padded back panel, padded shoulder straps, outside pocket(s) and may have a light waist belt. The capacity of these packs ranges from 1000 to 2500 cubic inches.



Frame Packs

A frame pack may be needed for extended backpack trips or for carrying heavier loads. A backpack may have a flexible internal frame or an external adjustable frame. The size and fit of the pack, frame and load must be appropriate for the person. The selection of a pack will be determined not only by the person using it, but also by the weight and bulk of items carried.

- **Youth Frame Pack.** A frame pack designed for a youth whose body will be changing up and out with time. It carries a smaller load (2000 - 4000 cubic inch capacity) and has an adjustable frame, outside pockets, and padded shoulder straps and hip belt.
- **Expedition Frame Pack.** An internal or external frame pack is used for expeditions or camping for several days and would need to be larger (4500 - 6000 cubic inch capacity) and offer more features.



Youth Frame Pack



Expedition Frame Pack

*"Humble yourself therefore under the mighty hand of God, so that He may exalt you in due time, casting all your care upon Him, because He cares for you."
(1 Peter 5:6-7)*

How to Pack Your Pack

Whether you are using an external or internal frame pack, always distribute your loaded weight evenly horizontally and vertically. When hiking on trails, keep heaviest items packed close to the back of the pack (closest to your back and centered between your shoulders), and packed from the middle to the top portion of the pack. Medium weight items should be packed in the mid portion of the pack (away from the pack back) with the lightweight items packed in the lower portion of the pack.

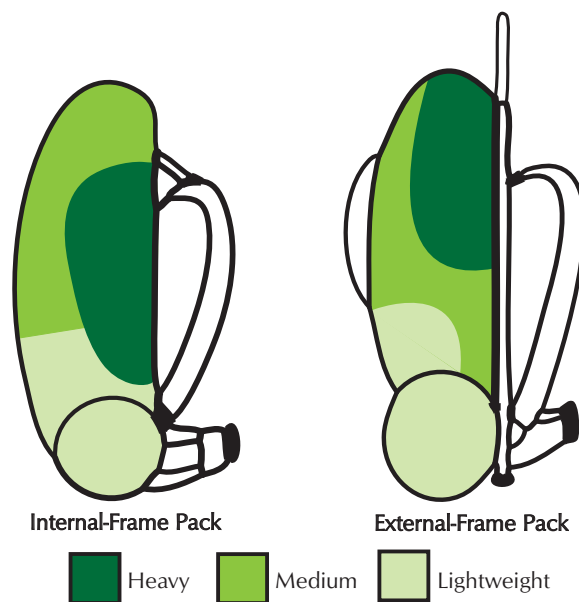

This layout helps focus more of the pack weight over your hips and legs, the area of the body best equipped to carry a heavy load. Some hikers reverse this procedure when hiking difficult terrain to lower the center of gravity and allowing for greater control of the load.

Should you find the center of gravity too high or too low, simply stop and readjust the load. Time and experience will help determine what is comfortable for hiking up hill or down hill, on a trail or bushwhacking across country. If the pack is packed correctly, the weight will be carried on the hips with the thigh muscles doing the work.

Separate and arrange packed items using individual ditty bags or plastic zipper bags. Place these bags back in the pack in the same place and order after each use. This practice will aid you in locating the item you need quickly without disturbing the entire pack.

- **Clothes.** Pants, shorts, shirts, socks, underwear, long johns, toboggan, gloves, windbreaker, wind pants and rain suit, etc. Warm layer items and rain gear should be placed in easy reach in the event of weather changes (top area of pack).
- **Technical Items.** Bible, note pad, pencil, maps, compass, etc.
- **Sleeping Bag.** Strapped on the bottom of the external frame pack (stored in a water proof bag or plastic trash bag) or stuffed in the bottom of the internal frame pack.
- **Cooking Gear.** Pack the stove in the lower section of either type pack. Pack fuel cells in the lower portion of the internal frame pack or in one of the lower outside pockets of the external frame pack. Make sure the caps on the stove and fuel cells are tight to prevent leaking. (Consider packing the fuel cells in heavy, plastic zipper bags.) These locations will minimize the contamination of fuel with food and gear in the event of a leak.

- **Food Bag.** Pack in top portion of the internal frame pack and on top of external frame pack. Use a 30 gal. trash bag as a liner inside the food bag to contain any leaks. Consider separating foodstuffs by meal types: breakfast, lunch (munchies) and dinner.
- **Quick Access Items.** Rain gear, camera, compass, map, layer clothing, etc. For the internal frame pack, put these items close to the top of the pack and for the external frame pack, put these items in the map or side pockets.

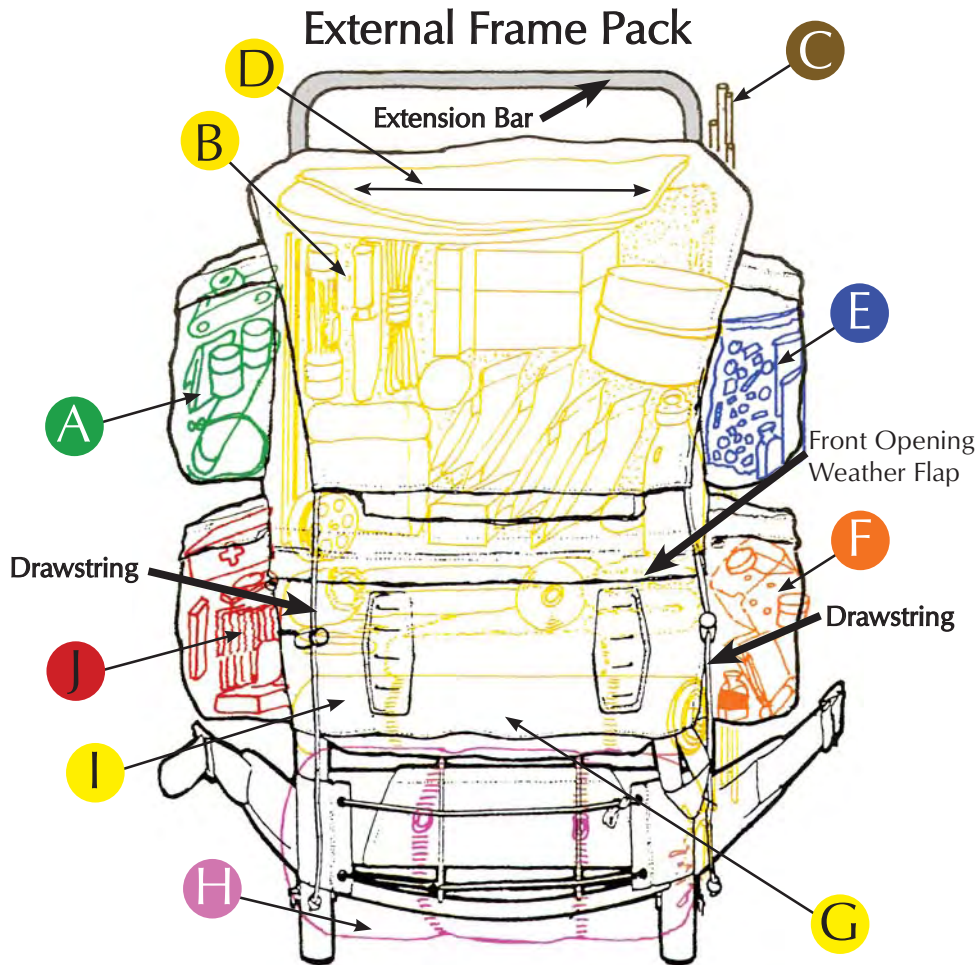

A Camera, film, mini tripod, cable release, close up attachments, sun glasses, fire permit, notebook

B **Upper Pack Body**
Camp shoes, poncho, set heavy clothing (cold weather), food, plastic bags, nylon cord, sheath knife, clothing (socks, underwear, shirts, shorts)

C Tent poles

D Nylon food bag (strapped on top to extension bar), tent, ground sheet

E Trail snacks, energy bars, jerky

F Small water bottle, fruit drink mix, water purification treatment, suntan lotion, foot powder, insect repellent, lip balm

G **Lower Pack Body**
Clothing, toiletry articles

H Sleeping Bag (strapped on outside)

I Mattress/pad (strapped on outside)

J Extra batteries, first aid kit, map and compass, matches, spare pack fittings, odds-and-ends can, trowel, toilet paper

- Notes -

*"Come to Me, all of you who are weary and burdened, and I will give you rest. All of you, take up My yoke and learn from Me, because I am gentle and humble in heart, and you will find rest for yourselves. For My yoke is easy and My burden is light."
(Matthew 11:28-30)*

How to Put on a Pack

The following instructions are for a right handed person. A left handed person can reverse sides.

Stand your pack in front of you on the ground. Be sure that the belt ends are spread out and the shoulder straps are extended. Stand with your right foot ahead of the other, bend the right knee slightly forming a platform with the knee. Lift the pack to the platform with the straps facing you.

Run your left arm through the left shoulder strap fully, swing the pack onto your back, bend forward slightly, and slip the right arm through the right shoulder strap. While still leaning forward, lift the pack high on your back and tighten the shoulder straps until snug. Stand upright, snap the hip belt ends and tighten the belt on your hips. Loosen the shoulder straps allowing the weight of the pack to rest on the hips and then snug the shoulder straps to keep the top of the pack close to the shoulders. The weight of the pack should rest on the hips, not on the shoulders. Adjust your straps until you have your pack in a comfortable carrying position.

When you are ready to remove your pack, step off the trail and reverse the previous steps. Lower the pack gently to the ground to keep from damaging your pack or equipment. Try not to stand your pack in the sun, if possible.



Using A Pack

- Notes -

- Take care of your pack.
- Don't strain yourself by lifting with your back. Lift with your legs. Lift an internal frame pack with the lifting loop at the top and use the top frame to lift the external frame pack.
- Stay relaxed. Walk with a natural, steady, easy stride.
- Lean forward from the hips (5 to 30 degrees depending upon the grade of the trail) keeping the weight over the hips.
- In mountain backpacking, take many short rest stops.
- In situations of unsure footing, be ready to release and drop the pack.
- Never wear a pack in a boat or canoe.
- Keep the pack as dry as possible.
- Use a pack rain cover when it is left outside or bring the pack into your tent.
- Suspend the food bag where animals can't get to the bag.
- Don't pack or take anything you don't really need.



"Then Jesus came near and said to them, 'All authority has been given to Me in heaven and earth. Go, therefore, and make disciples of all nations, baptizing them in the name of the Father and of the Son and of the Holy Spirit, teaching them to observe everything that I have commanded you. And remember I am with you always, to the end of the age.'"
(Matthew 28:18-20)

Canoe Equipment

The equipment needed will depend on trip conditions, number of persons, where you are going and length of trip. Take only essential equipment and use watertight bags or containers. Life jackets are mandatory.

- Canoes (1 per 2 people)
- Paddles (1 per person and 1 spare per 2-3 canoes)
- Life jacket (1 per person and 1 spare per group)
- Bailing buckets
- Food and drinking water
- Cooking equipment (stove, utensils, pots etc.)
- Shelter (tent or rain fly)
- Extra rope (100' per canoe)
- Group first aid kit
- Fire permit (if required)
- Canoe repair kit (Duct tape)
- Shovel
- Trash bags
- Map and compass
- Lantern and flashlights
- Fuel and spare batteries
- Clothing
- Wet shoes (water shoes)
- Personal hygiene items



- Notes -

"He said to him, 'Love the Lord your God with all your heart, with all your soul, and with all your mind. This is the greatest and most important commandment. The second is like it: Love your neighbor as yourself. All the Law and the Prophets depend on these two commandments.'"
(Matthew 22:37-40)

Tips on Equipment and Shelter

- Equipment is easier to repair prior to leaving on your trip. Check all equipment before your trip.
- Set up your tent before leaving to inspect and inventory all components (poles, stakes, ropes, etc.). Be sure you are familiar with the setup process in case you have to set up in a hurry or after dark.
- Compare prices with several suppliers prior to purchasing equipment. Consider renting equipment to check it out.
- Cover your firewood at night.
- A bow saw and pocket knife will do most cutting that an axe will do and do it safer.
- Lock your billfold, licenses, credit cards, money etc. in a safe place.
- Take spare batteries, bulbs, lantern mantles and fuel.
- Check your film supply prior to leaving.
- A disposable, adjustable flame lighter is a good supplement to matches.
- Sneakers work well as canoe shoes and will not leave marks or scratches.
- Use waterproof bags to store equipment and supplies.

"Be prepared and get yourself ready, you and all your company..."
(Ezekiel 38:7)



ROPE CRAFT



- ✓ Know the Ropes
- ✓ Rope Materials
- ✓ Rope Construction
- ✓ Properties of Rope
- ✓ Whipping the Ropes
- ✓ Knot Tying
- ✓ Types of Knots
- ✓ Splicing
- ✓ Lashing
- ✓ Knot Board
- ✓ Rope Machine

- Notes -

In 1793, as William Carey, considered the Father of the Modern Mission Movement, was making preparations to board a ship to India, he used the analogy that he felt he was being lowered into a dark well by a rope. He was not afraid as long as he knew that his faithful friend, Andrew Fuller, would hold onto the rope by praying and giving to support the mission work. This is not a task that can be accomplished alone. Will you remain faithful and hold onto the rope of missionaries by praying for and giving to missions? Have you ever sensed that God has been calling you to tie the rope around yourself and be on mission with Him? Pray and ask God to reveal to you how you are to respond to His invitation to join Him in accomplishing His mission.

Know the Ropes

Rope is made of animal, vegetable or mineral fibers. The fibers are twisted in one direction into strands and then the strands are twisted the opposite direction to make the rope. Sometimes fibers will be woven or braided into ropes of small diameter. Most of the time, rope is measured by the diameter in fractions or in millimeters. Marine applications will generally measure a rope by circumference.

Care of Rope

Store ropes in a cool, dry place. Keep the ropes clean and free of mud, grease, etc., as possible. Coil and uncoil ropes carefully to avoid kinks. Whip the ends of natural ropes or burn the ends of synthetic ropes to prevent the ends from unraveling. Be sure to inspect your rope periodically. Replace worn spots in ropes by splicing. Carefully evaluate replacing your ropes when signs of wear, such as broken fibers, are apparent.



Selection of Rope

There are several important considerations to keep in mind when selecting a rope. The material it is constructed from determines the properties and application of a rope. The construction of the rope is a key factor when selecting a rope. Working loads are generally 10% (between 8% and 14%) of tensile strength of a rope. A knot will reduce the working load of a rope up to 50%. Misuse of ropes could result in loss of load and possible serious injury. Be sure to know the capabilities and usages of your ropes. Consult the rope manufacturer concerning characteristics and working conditions for the ropes that you will be using.



Rope Materials

- Notes -

Natural Fibers



Manila Rope

Manila comes from the Abaca tree, is yellowish with a silky feel and is considered the strongest and best natural rope material.

Ropes have different strengths and uses. Christians also have different strengths and uses. Strands of fibers together make the rope strong. Christians serving together makes strength.

Sisal comes from the leaf of Agava plants and is often used as a substitute for Manila. The fibers are stiff and rough with no silky feel and break easily.



Sisal Rope



Jute Rope

Jute is from the Jute plant, is dark in color, very soft, frays easily and is mainly used in crafts.

Cotton is the best natural teaching rope because it is soft and pliable. But it frays and breaks easily and will also shrink.



Cotton Rope

- Notes -

Rope is tight, unfrayed, and straight when new. Rope gets frayed with use - just as we do with problems and sin in life. Can you think of ways to keep your life from becoming frayed?

Synthetic Materials



Nylon Rope

Nylon rope is soft and easy to handle. It stretches easily and knots will slip out of the rope. It does not rot, is resistance to abrasion and will last much longer than natural ropes.

Polyester is a very strong synthetic rope that is resistant to abrasion and does not stretch like nylon. Polyester ropes have a tendency to feel stiff to the touch.



Polyester Rope



Polypropylene Rope

Polypropylene is a lightweight rope that can float on water and is resistant to most chemicals. Polypropylene ropes are affected by prolonged exposure to direct sunlight.

Polyethylene is the lightest synthetic fiber rope. It is resistant to chemicals and can float on water. A polyethylene rope is not as strong as a polypropylene rope of the same size.



Polyethylene Rope

Rope Construction

- Notes -

Laid Construction.

Also known as a twisted rope and is usually constructed with 3 strands. It is spliceable and is available in virtually every type of rope fiber. This is the most common rope construction for general-purpose use.



Solid Braid Construction.

A firm, round rope that works well on blocks and pulleys. Its name refers to the special lock-stitch construction of the rope. Solid braid rope does not unravel when cut, unlike other types of rope construction. It is available in various synthetic fibers.

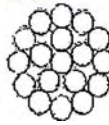

Diamond Braid Construction.

Also known as hollow braid and maypole braid. This rope is constructed with a hollow center. This rope can be spliced in just seconds and is available in various synthetic fibers.



Braid-On-Braid Construction.

Also known as double braid. Actually two braided ropes combined into one rope. A braided core is covered with a braided jacket to produce a strong, easy handling rope. This rope is spliceable and is available in various synthetic fibers.



Kernmantle Construction.

It is a generic term of German derivation where mantle refers to the cover and kern the core. Specially designed ropes for use in mountain climbing, rescue, rappelling and certain safety applications. These ropes are designed for specific uses and should be used only after proper training.



"And if somebody overpowers one person, two can resist him. A cord of three strands is not easily broken."
(Ecclesiastes 4:12)

Properties of Rope

**** = BEST TYPE

	COTTON	SISAL	MANILA	NYLON	POLYESTER	POLYPROPYLENE POLYETHYLENE
Shock Load	*	*	**	****	**	***
Rot Resistance	*	*	*	****	****	****
Mildew Resistance	*	*	*	****	****	****
Sunlight Resistance	****	****	****	**	****	*
Heat	no affect	no affect	no affect	weakens at 350°F.	weakens at 350°F.	weakens at 150°F.
Storage	must store dry	must store dry	must store dry	can store wet or dry	can store wet or dry	can store wet or dry
Oil & Gas Resistant	**	**	**	****	****	****
Acid Resistance	*	*	*	***	****	****
Abrasion Resistant	*	**	***	****	****	**
Durability	*	*	***	****	****	***
Handling	****	*	**	****	***	***
Floats	no	no	no	no	no	yes

Whipping the Ropes

Binding or whipping the ends of a rope makes it more useful, last longer and easier to use. Christ binds our life together, makes us useful, and keeps us from getting "frayed."

A good rope deserves good care.

One way to keep your rope in good condition is to "whip" the ends to keep them from unraveling. To whip the rope, use a fine cord or thread. Place the end of the cord at the end of the rope and lay a loop along the rope and lay a loop along the rope. Then wind the cord tightly around the loop and rope, thus binding them together. Wind to a distance roughly equal to the thickness of the rope. Finish the whipping by putting the winding end (B) through the loop and pull end (A) tight until the loop is drawn back out of sight. Cut both ends of the cord short to make a neat finish.

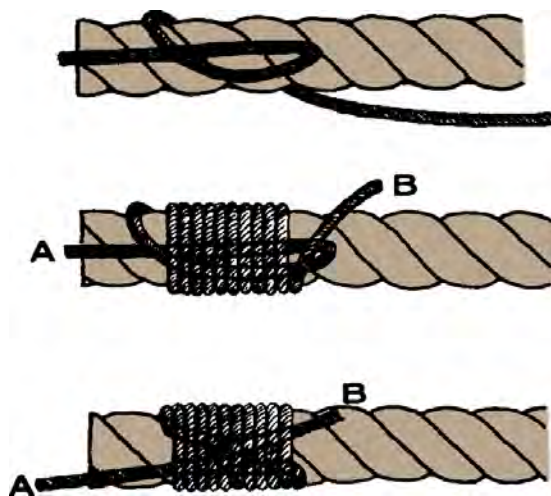

Knot Tying

Three things to know about a knot:

- Its name
- Its use
- How it is tied

In knot tying a rope has three parts:

- The **end** is the end of the rope with which you are working when you tie a knot.
- The **standing part** is the length of the rope not being used.
- The **bight** is the central part of the rope between the working end and the standing part of the rope.



*“And whatever you do, in word or deed, do everything in the name of the Lord Jesus, giving thanks to God the Father through Him.”
(Colossians 3:17)*

An **overhand loop** is made by crossing the end over the standing part.



An **underhand loop** is made by crossing the end under the standing part.

A **turn** is made by looping the rope around any object – often another section of itself.



A **round turn** is taken by looping the rope twice around an object.

Always tighten a knot slowly and evenly to avoid kinking the rope. Quick, careless tightening may mean a tangle.

- Notes -

*“For the body is one and has many parts, and all the parts of that body, though many, are one body – so also is Christ.”
(1 Corinthians 12:12)*

Just as there are different types of knots for different uses, so also Christ gives different talents to His disciples to accomplish the tasks He assigns us.

Types of Knots

Stopper Knots

Stopper knots are used to prevent a rope from sliding or being pulled through an object. Stopper knots are generally tied in the end of a rope.

Overhand Knot

The Overhand Knot is the simplest and smallest stopper knot. It is generally used on small cord or twine, since it jams and is hard to untie. To tie: make an overhand loop, pass the end under and up through the loop. Draw tight.



Figure Eight Knot

The Figure Eight Knot is a stopper knot that is easier to untie than the overhand knot. To tie: make an underhand loop, bring the end around and over the standing part, pass the end under and then up through the loop. Draw tight.



Double Overhand Knot

The Double Overhand Knot is tied like the regular overhand except pass the end under and up through the loop two times instead of just one. This makes a larger knot to stop the rope from sliding through a hole or a loop of another knot.



Figure Eight Double Knot

The Figure Eight Double Knot is tied like the regular figure eight but two ropes are used.



Joiner Knots

Joiner knots are used to tie two ropes together.

Square Knot (Reef Knot)

The Square Knot is a joiner knot used to join two ropes or strings of the same thickness. To tie: pass the right end over and under the left end, curve what is now the left end towards the right, cross what is now the left end over and under the right. Draw tight.



Tie a square knot while telling that if you keep your eyes on Jesus you will always be in the right and your life will hold because this knot won't slip.

- Notes -

Knots tied wrong may look right - but will slip and not hold. The Christian life can not be faked.

Granny Knot

Don't tie the weak Granny Knot. Remember, the square knot has two ends lying together under one loop and over the opposite loop. The Granny has one end under and one over on both loops. This knot will slip under pressure.



Surgeon's Knot

The Surgeon's Knot is often used for twine – chiefly to keep the first tie from slipping before the knot is completed. To tie: with the right end, take two or three turns about the other end, bring both ends up, pass the left end over and under the other end similar to the square knot. Draw tight.



Fisherman's Knot

The Fisherman's Knot is very strong and is commonly used by anglers. To tie: lay the two ends together – each pointing in the opposite direction, tie an Overhand Knot in the end of each – around the standing part of the other. When drawn tight, the two knots slide together and will not slip.



Sheet Bend Knot

The Sheet Bend is for joining ropes of different sizes. To tie: form a bight on the end of the larger rope and hold firmly in your hand, then pass the end of the smaller rope from below up through the bight, bring the end of the smaller rope around and under the bight of the larger rope, then slip it under its own standing part and continue over the bight of the standing rope. Tighten by pulling the standing part of both ropes.



Carrick Bend Knot

The Carrick Bend Knot is one of the strongest knots. It cannot jam and unites easily. To tie: with one rope-end form an underhand loop – with both the end and standing part pointing away from you, start the second rope beneath both sides of the loop, take the end of the second over the standing part of the first rope, then under the end of the first rope, then over the left side of the loop, then under itself – and let the second end lie over the right side of the loop. Finish by pulling on the standing parts of both ropes.

*“For nothing will be impossible with God.”
(Luke 1:37)*



Bow Knot

The Bow Knot is used for tying your shoe laces. Before starting the Bow Knot, make sure the laces are pulled snug. To tie: with a shoe lace in each hand, pass the left lace over and around the right lace, firmly pulling the ends in opposite directions forming an overhand knot. With the left hand lace make and hold a medium sized loop as shown. (Loop)



Overhand Knot

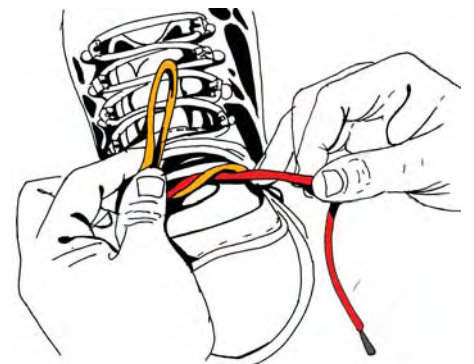

Loop

Now pass the right hand lace over and around the neck of the loop as shown. (Swoop) With the right hand lace form a bight and pass under itself forming a small loop. Grasp a loop in each hand. Pull firmly in opposite directions forming two equal sized loops as shown. (Pull) To untie the Bow Knot pull on the ends of the laces.

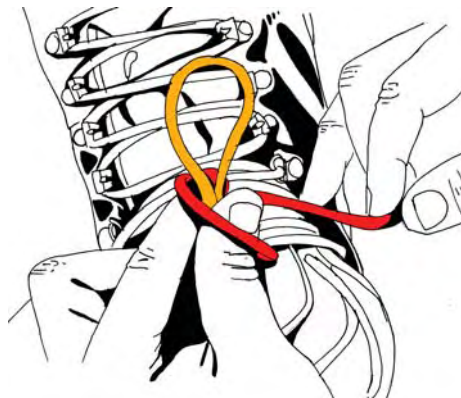

Swoop



Pull

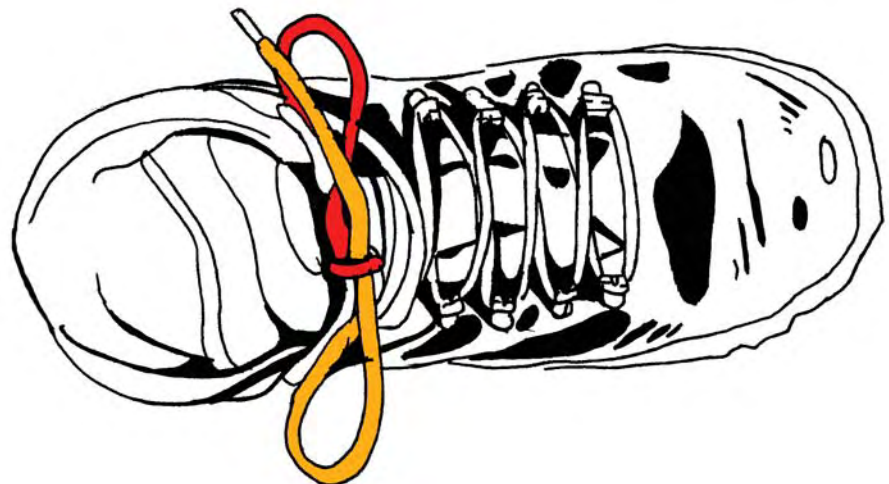

Bow Knot

Tiller's Knot

The Tiller's Knot unties easily and is especially useful when there is tension on the rope. To tie: make a bight with the end of one rope, pass the end of the other rope from below, up through the bight of the first rope and bring the end of the second rope around the bight of the first rope. Cross it over the standing part of the first rope and then form a bight under the second rope as illustrated. Finish by drawing the knot tight.



Loop Knots

Loop knots create a loop in the rope that remains usable until untied.

Bowline Knot

The Bowline is used for securing items or lifting. The Bowline Knot is often called the "king of knots" because it never jams or slips if tied correctly. To tie: make an overhand loop with the end held towards you, pass the end up through the loop, then up behind the standing part, then down through the loop again. Draw tight.



When tying a bowline, compare the standing part of the rope to your spiritual life. As you tie the knot, tell how Jesus comes into the door of your life, puts His arms around you and never lets go.

Double Bowline Knot

The Double Bowline makes a good sling for lifting and lowering people or objects. To tie: make an overhand loop with the end held towards you, exactly as in the ordinary Bowline. The difference being that you pass the end through the loop twice – making two lower loops. The end is then passed behind the standing part and down through the first loop again as in the ordinary Bowline. Pull tight. For rescue use one loop under the arms and use the other loop to form a seat.



Running Bowline Knot

The Running Bowline, also known as the Bowline on a Bight, creates an adjustable loop knot. Tie the regular Bowline around its own standing part to create the adjustable loop.



Man Harness Knot

The Man Harness Knot is used for hauling. This knot should be tied large enough to go around the object. To tie: make a loop in the rope and fold it forward and slightly to the right to get the loop shaped like the one in the first image. Then take up and under and over, as shown in the second image. To finish the knot, yank hard to the left.



*"If you continue in My word, you really are my disciples. You will know the truth, and the truth will set you free."
(John 8:31-32)*

Taut-Line Hitch

The Taut-Line Hitch is an adjustable loop knot. To tie: create a loop, then bring the end over and under the standing part twice through the loop formed, take the end over the loop and the standing part of the rope, then back under itself. Work the hitch until it is taut around the standing part. The hitch can be moved by pushing it up and down the standing part.



End Securing Knots

End securing knots, also known as Hitches, are generally used to secure the end of a rope to an object.

Clove Hitch

The Clove Hitch is a quick simple method of fastening a rope around a post or stake. It is used to begin lashing. It will slip when used at the end of a rope. To tie: make a turn with the rope around a post and over itself, take a second turn around the post, place the end under the second turn. Tighten by pulling both ends in opposite directions.



Half Hitch

The Half Hitch is generally used for fastening to an object for a right-angle pull. To tie: pass the end of the rope around the object and go around the standing part and back under the turn. This is the first step in tying more complicated hitches. The illustration shows the Half Hitch tied with the end nipped under the turn of the rope some distance away from the standing part – this method is fairly reliable for temporary use – if the pull is steady and the arrangement is not disturbed.



Double Half Hitch

The Double Half Hitch is used to make a rope fast to a ring or post. It is simply two Half Hitches tied around the standing part of the rope. It is more reliable than the single Half Hitch. It will also adjust to loosen or tighten the rope.



Timber Hitch

The Timber Hitch is a simple convenient hitch that does not jam and is untied easily when the pull ceases. It is used mainly to tow or hoist cylindrical objects, such as logs. To tie: pass a rope around the object and take a turn with the end around the standing part, then twist or turn the end back around itself following the lay of the rope. Three turns back are generally sufficient.



Cow Hitch

The Cow Hitch is used for tethering, mooring, and hoisting. To tie: double the end of a rope to form an open loop, reach through the loop and grasp the end and standing part and pull them back through the loop. Place the double loop formed over a post and draw up tight.



Other Knots

Sheepshank

The Sheepshank is intended to shorten a rope for temporary use only. Carefully tied and drawn up tight, it is fairly reliable under a steady pull. To tie: form an S loop as shown in the diagram, then with one free end of the rope make a Half Hitch and slip it over one of the loops and tighten. Repeat procedure with the other loop.



Tie several slip knots in a rope and wad it up. Tell how our lives can get all tangled because of sin and we can never get untangled from our situation without Christ. Tell how Jesus can restore our relationship with Him and straighten out our lives as you pull the knots out of the rope.

Slipknot

The Slipknot forms a easily removable loop. To tie: form an overhand loop, then insert a bight into the loop.



Trucker's Hitch

Use this knot to cinch down a load on your car top, boat, horseback, etc. This combination of knots allows a rope to be pulled extremely tight. To tie: tie off one end of the rope, lay rope over the load to be tied down, tie a slip knot in the middle of the rope and form a small loop, with free end make a turn around a fitting and bring the free end back up to the loop in the rope, feed through and pull the rope very tight. Secure the knot with a Tiller's Hitch to allow you to untie the knot easily.

Splicing

Splices are used to mend a damaged rope or to fasten one rope to another. A good splice has up to 95 percent of the rope's strength, while a knot's efficiency varies from only 45 to 60 percent of the rope's strength. The Long Splice allows a rope to run through a block or pulley, and should be made only with two ropes of the same size. The Long Splice is time consuming and uses up considerable rope. The Short Splice is the strongest way to join two ropes, can be made quickly, and involves little rope waste although the disadvantage is that it cannot pass through a pulley. The Eye Splice is used to create the strongest loop in the end of the rope. The End Splice can be used to replace whipping to keep the end from unraveling.



Short Splice

Splicing Tips

- Whip or tape the end of the strands to prevent fraying during splicing.
- A splicing tool can aid in making splices.
- Twist the rope slightly against the lay of the rope to raise the strands open in order to tuck the strands being spliced into the rope.
- Tuck the working end of the strands away from the splicer.
- Roll the rope towards the splicer a third of a turn after each tuck.
- A good splice should have a neat uniform appearance.
- A minimum of three to four tucks is recommended per strand.
- When splicing any of the synthetic ropes, add at least one extra tuck per strand.
- Roll and pound tucks into the rope and clip the strand ends to finish the splice.



Buddy Rope

- Notes -

"The Father and I are one." (John 10:30)

Jesus came to Earth as God in man.

"I pray for them. I am not praying for the world but for those You have given Me, because they are Yours. All My things are Yours, and Yours are Mine, and I have been glorified in them. I am no longer in the world, but they are in the world, and I am coming to You. Holy Father, protect them by Your name that You have given Me, so that they may be one as We are one." (John 17:9-11)

We are spliced together with the Father when we become a Christian for we are spliced together by Jesus Christ.

Long Splice

The Long Splice: A. Unlay (untwist) each rope end about 15 turns and place ropes together, alternating strands of each end. B. Using opposite pairs, unlay one strand (4) and fill its place with its "partner" strand (2). Repeat operation exactly with another pair of strands (1) and (6) in opposite direction. C. Trim the longer strand (4) and tie each pair of opposing strands (2) and (4) with an overhand knot, tucking each strand twice. The tuck goes over one strand, under the second, and out between the second and third. Strands (3) and (5) are simply tied with an overhand knot. Strands (1) and (6) are halved, and opposite strands are tied with an overhand knot before tucking. D. Roll and pound tucks into the rope and clip the strand ends.

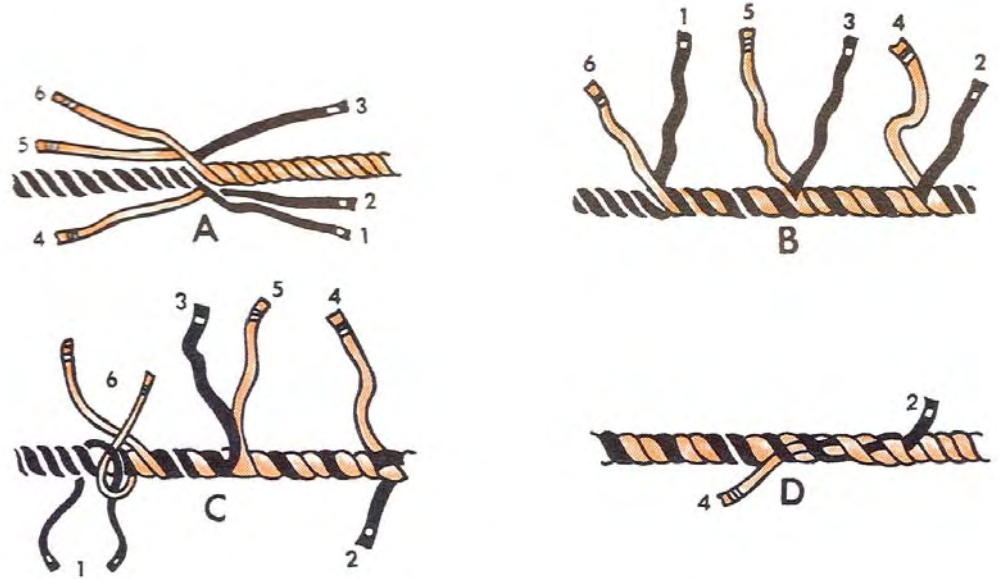

Short Splice

The Short Splice: A. Unlay each rope a few turns and alternate the strand. B. Tie the strands down to prevent further unlaying. C. Tuck one strand (1) over an opposing strand, and under the next strand. D. The tuck of strand (2) goes over the first strand (5), under the second, and out between the second and third. E. Repeat operation with the other two strands (1) and (3) from the same rope end. F. Remove tie and repeat operation on other rope end. Make two more tucks for each strand. Roll tucks into the rope and clip the strand ends.

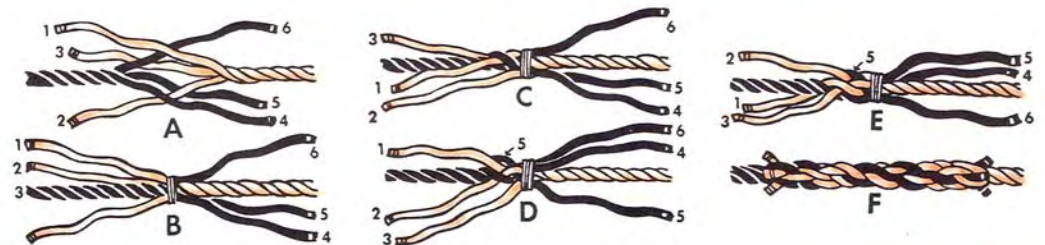

End Splice

The End Splice: A. Unlay the ends of the rope at least 5 lays. B. Fold strand (2) down between strands (1) and (3), leaving a small loop. C. Take strand (1) over strand (2) and down beyond strand (3). D. Take strand (3) over strand (1) and through the loop of strand (2). E. Pull evenly on each of the strands to form a triangular crown with the strands turned back down the rope. F. Strand (1) is tucked over (a) and under (b) and out between (b) and (c) Strand (2) is tucked over (b) and under (c) and out between (c) and (a) Strand (3) is tucked over (c) and under (a) and out between (a) and (b) Make two more tucks for each strand. Roll tucks into the rope and clip the strand ends.

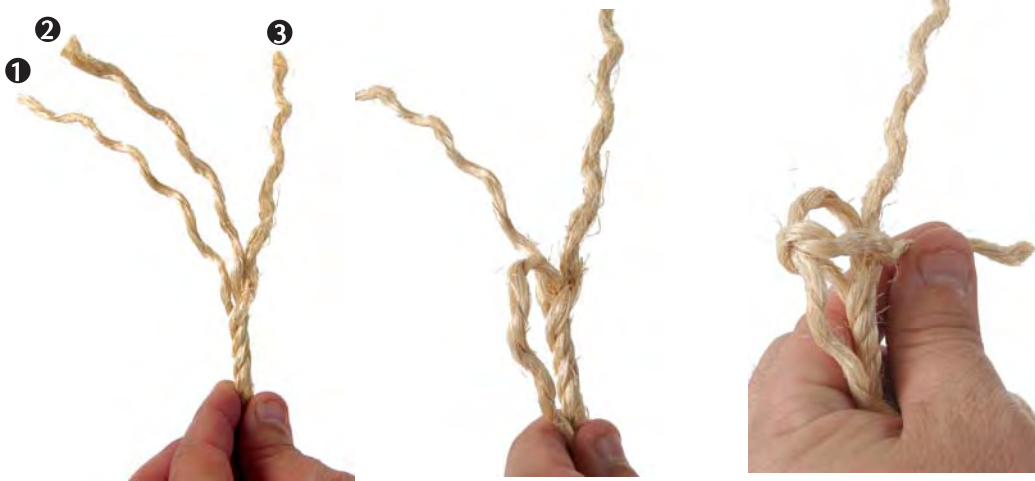

A

B

C



D



E



F

Eye Splice

The Eye Splice: The size of the eye will be determined by where the splice is started into the standing part. A. Unlay the end of the rope at least 5 lays. B. Strand (2) is tucked over strand (c), under (b) and out between (a) and (b). C. Strand (1) is tucked once over (b) and under (a) and out between (a) and (c). D. Strand (3) is tucked once over (a) and under (c) and out between (c) and (b). E. Make two more tucks for each strand. Roll tucks into the rope and clip the strand ends.

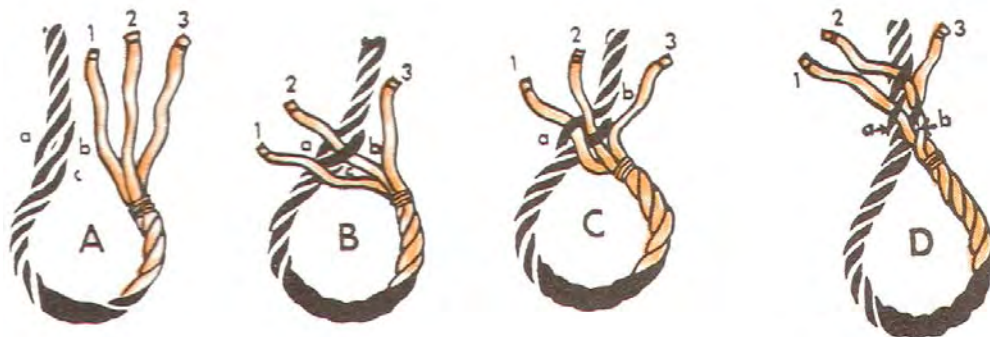

Lashing

Lashing is a way of joining sticks or poles together with rope or twine. Simple outdoor equipment can be quickly constructed to make outdoor living easier. Items needed for lashing include sturdy twine, knife or saw, sticks or poles.

*"I am the vine; you are the branches. The one who remains in Me and I in him produces much fruit, because you can do nothing without Me."
(John 15:5)*

When we receive Jesus Christ as our Lord and Savior we become lashed together and now are able to do more than we could when we were alone.

Square Lashing

Square Lashing is used to join two sticks together at right angles. You can make coat hangers, towel racks and other items. Begin by making a clove hitch on the vertical or upright stick with a long piece of twine. Be sure to leave several inches on the free end to complete the lashing.

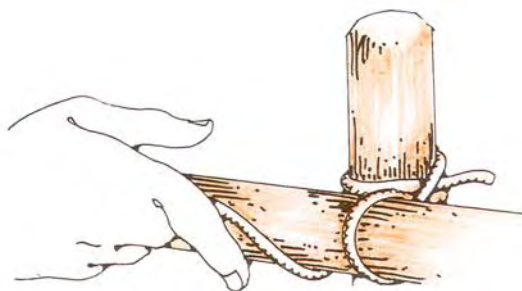
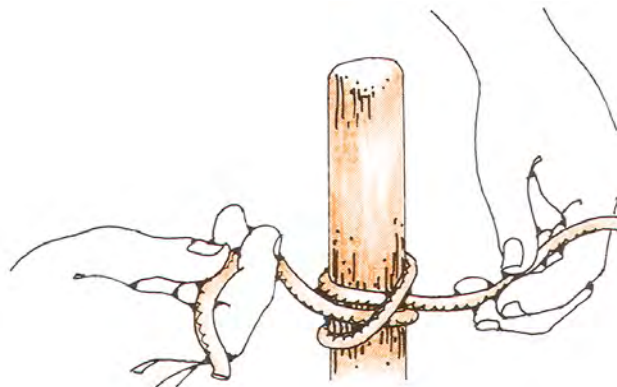

Pull the twine forward and over the front of the horizontal stick. Then pull the twine behind the vertical stick and around to the front. Next, pull the twine up in front of the horizontal stick.

Continue by pulling the twine around the upright and back to the starting point.

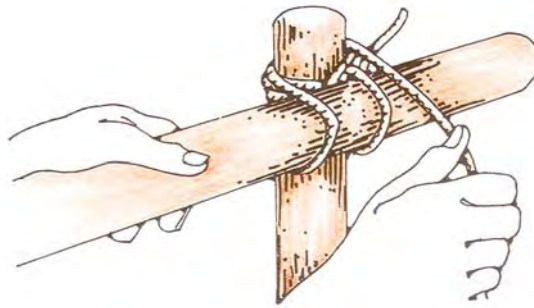

Repeat the same pattern three or four times, pulling tightly as each wrap is made.

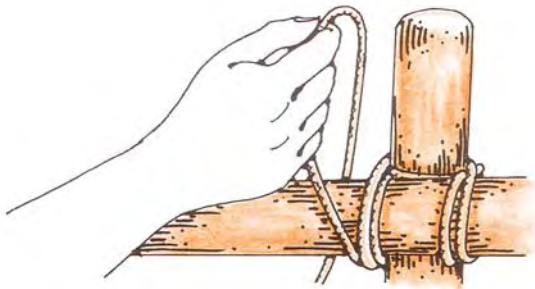

When the sticks are tightly wrapped, tighten the binding by frapping (winding the twine between the two sticks three or four times, pulling each wind tight).

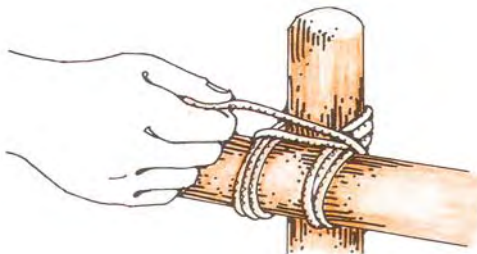

End with a square knot at the beginning point. Cut off ends and tuck them under the lashing.

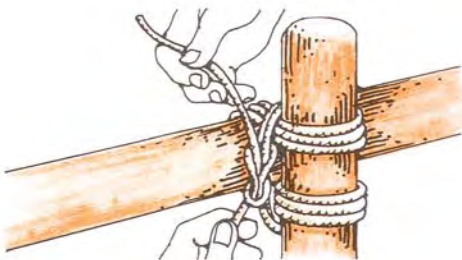

Diagonal Lashing

Diagonal Lashing is used to make racks and braces. Begin with a clove hitch around two or three sticks at the point where they cross. Make three or four horizontal winds.

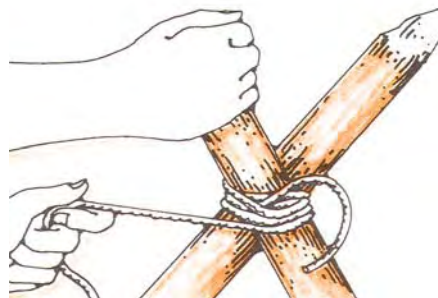

Then make the same number of vertical winds, pulling each turn tight.

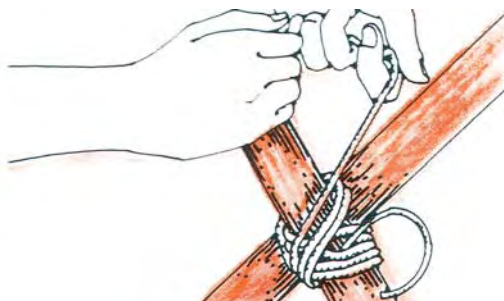

Frap between the sticks as in square lashing, winding three to four turns.

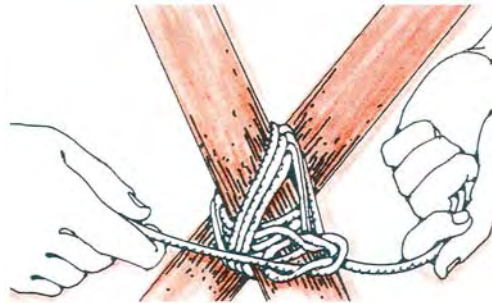
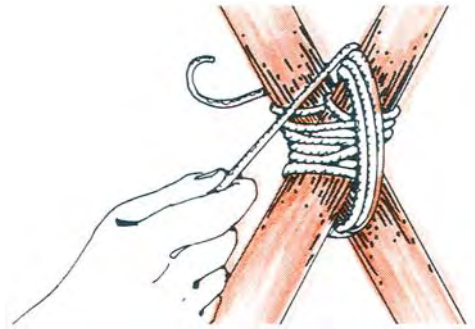

Pull windings tight and finish with a square knot.

Round or Sheer Lashing

Round or Sheer Lashing is used to join two parallel sticks. It is used to make pot hooks and to attach sticks to trees. Begin with a clove hitch on one stick.

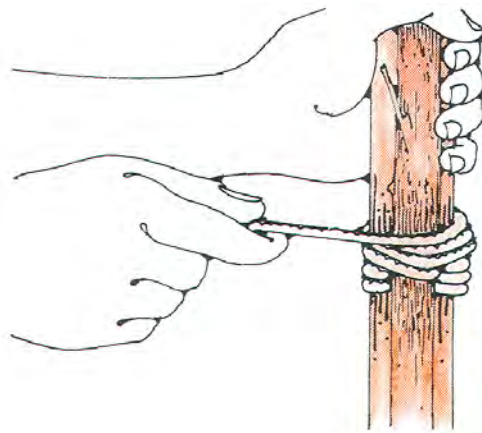
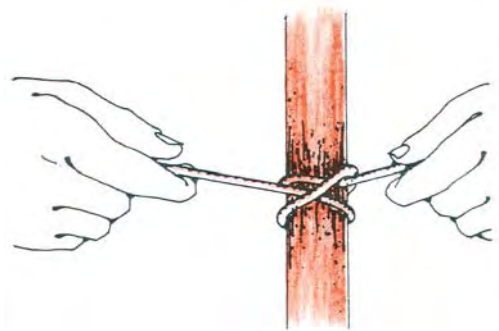

Place the other stick parallel and make parallel winds until the sticks are bound firmly.

Frap by pulling twine to the front and between the sticks.

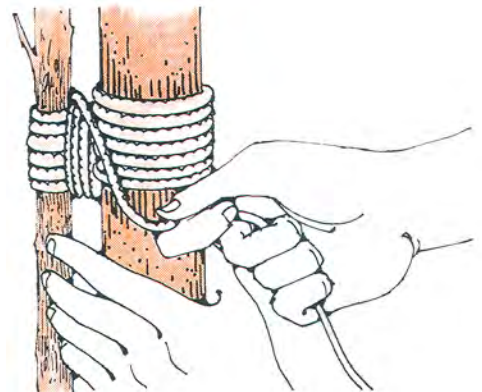

Make three or four winds pulling each wind tight and finish with a square knot.

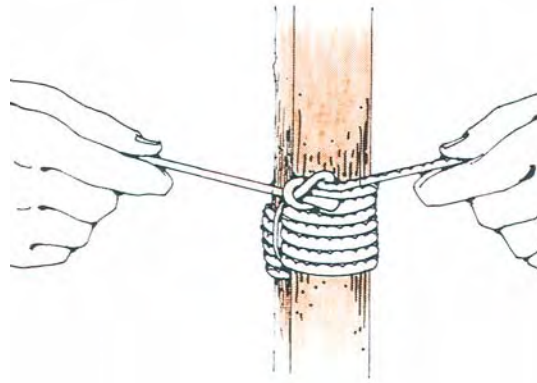

Tripod Lashing

Tripod Lashing is a type of Round or Sheer lashing where three poles are used and the windings are not made very tight. Begin with the center pole pointed the opposite direction of the other poles. Make several windings around the three poles. Frap between each pole, pulling tight. End with a square knot.

"I give thanks to Christ Jesus our Lord, who has strengthened me, because He considered me faithful, appointing me to the ministry." (1 Timothy 1:12)

Continuous Lashing

Continuous Lashing is used to make a table top or seats.

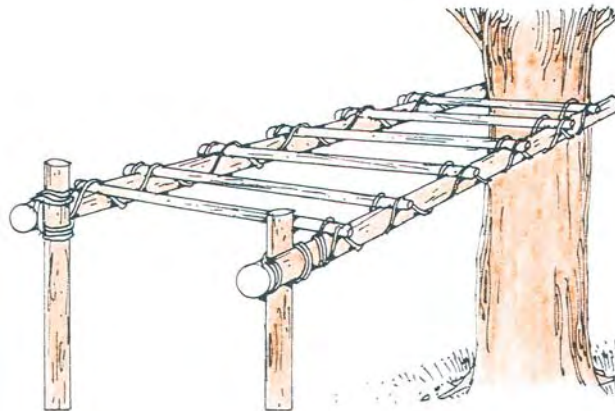

Every believer is called to be involved in God's mission and ministry. Pray about where God would like you to be involved.

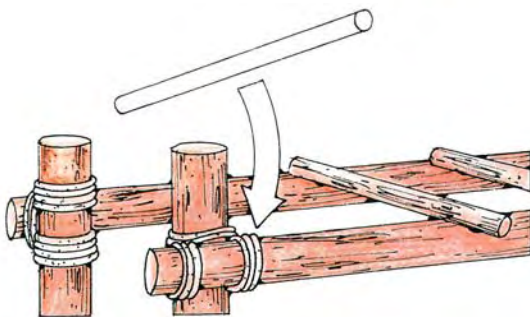

First, make a frame using square lashing. Cut and trim sticks to be used as cross pieces.

Start with a piece of twine long enough to completely lash each side. Tie a clove hitch around the frame in the middle of the twine with the knot underneath.

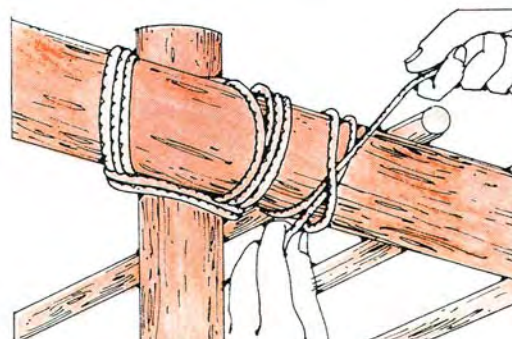

- Notes -

Take an end of twine in each hand and pull it up and over the first cross piece then pull it down under the frame.

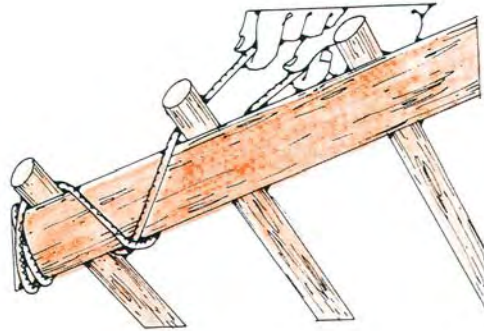
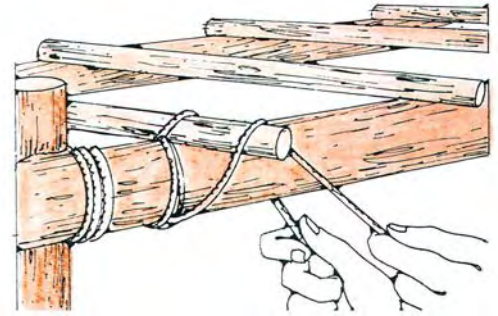

Cross the twine under the frame making an X, pulling the twine tight.

Bring twine up and over the next cross piece. Continue the pattern crossing the twine under the frame each time.

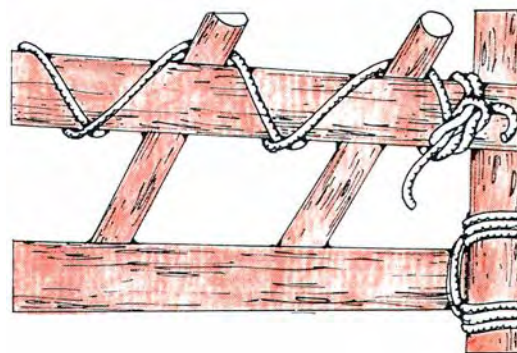
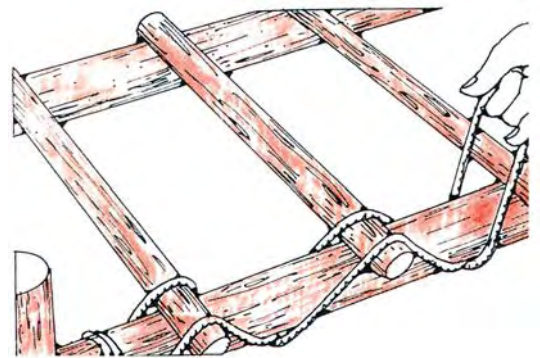

Pull the twine tight and finish with a square knot. Repeat on other side.

Knot Board

- Notes -

Learn to tie the four basic camping knots as illustrated as well as others you might add. Practice them until you can tie them well. Display them on a knot board made from a square of peg board (or plywood), white nylon cord, and fine wire. The knot board makes an attractive display for the chapter room or your own room at home.

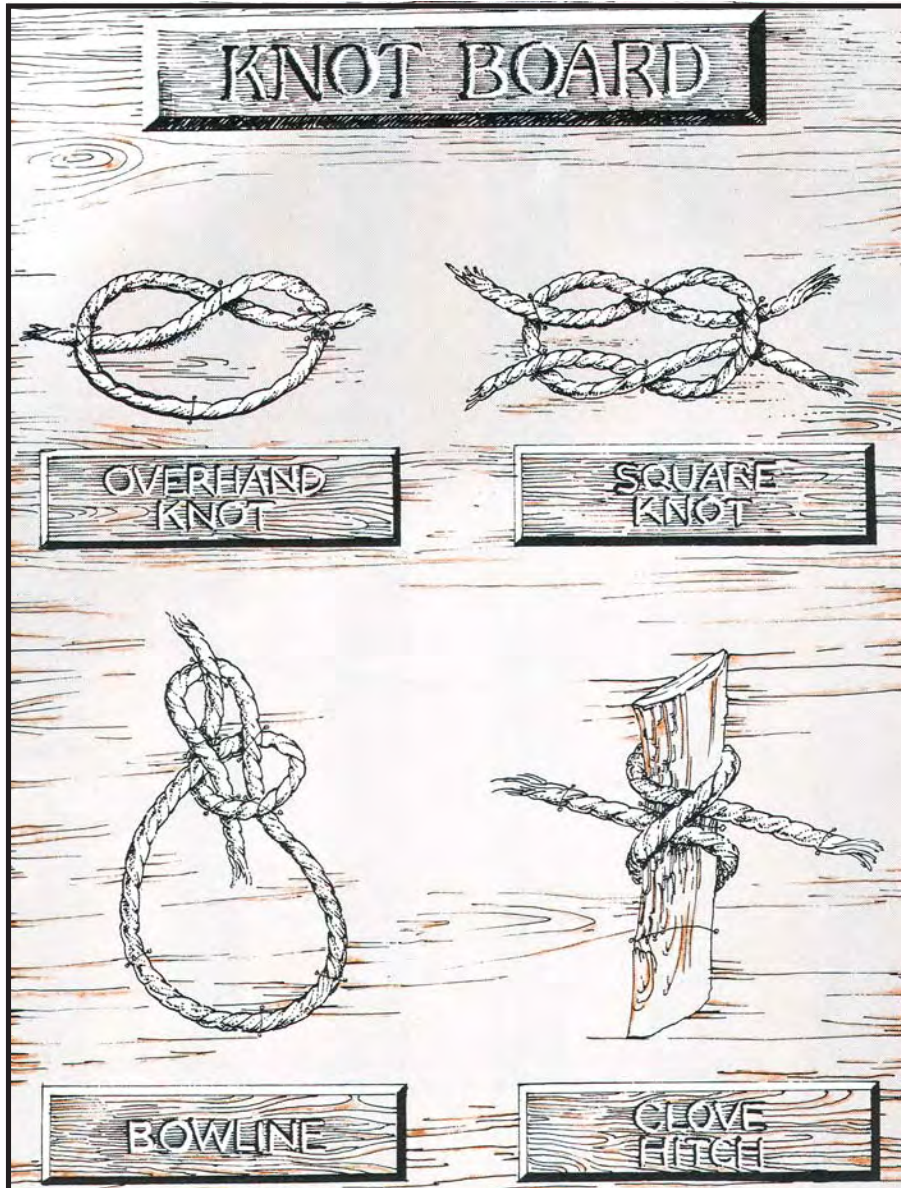
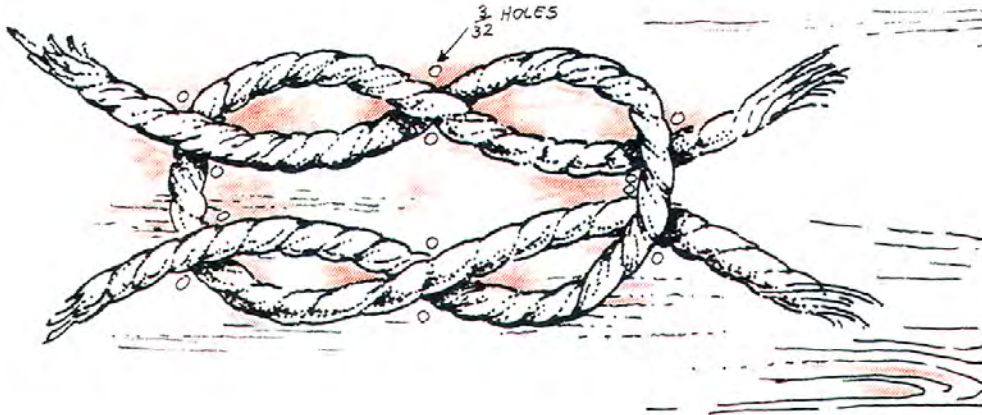

*"I am able to do all things through Him who strengthens me."
(Philippians 4:13)*

Rope Machine

Making your own rope with a rope machine is a fun group project that requires at least three people. Materials needed are 1/2 inch lumber, metal coat hangers, and screws or nails. Refer to the illustrations for dimensions and assembly.

The type of rope that is constructed by the rope machine is a three strand laid rope. This type of rope is made by twisting the strands of fiber in one direction (clockwise) and then laying the strands together in the opposite direction (counterclockwise). Any of the following materials may be used to make rope: binders twine, baler twine, plastic twine, jute twine, sisal twine, yarn, or string.

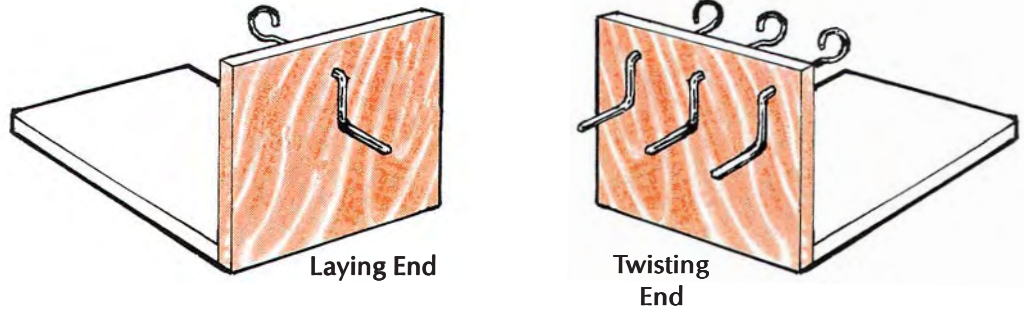

The primary parts of a rope machine are the twisting end (3 hooks), the one that twists the three strands, and the laying end (1 hook), the one that is used to lay the twisted strands together.

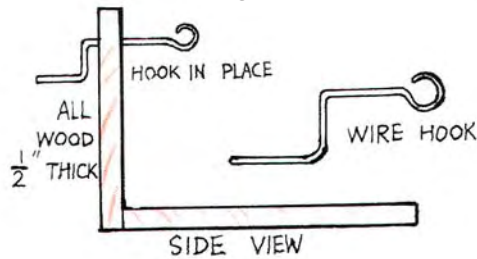

Anchor one of the end assemblies to a table with a "C" clamp or other method and have someone hold the other end. Tie the end of the twine to the laying end hook. Next hook the twine over one of the hooks on the twisting end, and then back to the laying end. Continue back and forth

until each of the three hooks on the twisting end has two lengths of twine. Try to keep the tension equal on each length of twine.

While keeping the laying end from turning, turn the handle on the twisting end so that the cranks are turning clockwise as you are looking at the handle. Twist the strands until they become firm and resist further twisting. Strands that are not twisted tight enough will cause the rope to be loose. Strands that are twisted too tight will kink. Experience will teach you when the strands are twisted just right.

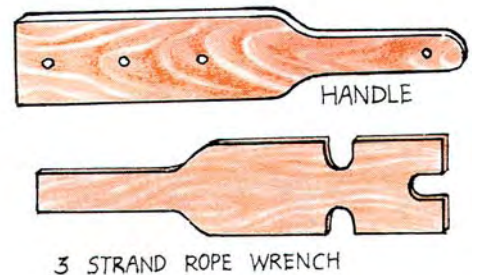

To complete or "lay" the rope, use the rope wrench to assist in laying the strands uniformly. The actual laying of rope is done by turning the laying end crank in a counterclockwise direction while moving the rope wrench toward the twisting end.

While twisting and laying the strands a modest amount of tension must be kept on the rope.

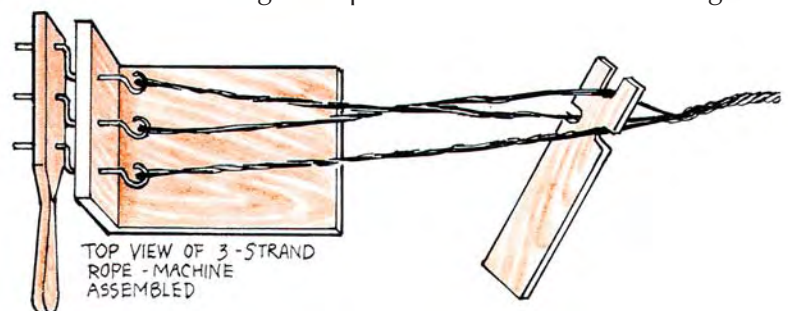

TOOL CRAFT

4



- ✓ Knives
- ✓ Saws
- ✓ Axes
- ✓ Other Tools

- Notes -

A knife is a tool in our hands. We are a "tool" in God's hands to do His work and will. God's Word is like a knife - it is sharp and cuts into the soul.

Without proper care, tools become dull and useless. So also with our Christian life. Give it proper care with worship, prayer and Bible study, so that we may be sharp and useful.

Knives

Pocket Knife

Today's modern knife can trace its beginnings back to early man's crude hand held sharp-edged tools. In order for a knife to be useful it must be taken care of and treated with respect. A knife can be used either as a tool or a weapon. The difference is in who's hand is controlling the knife. Each person must decide how they will handle the knife in their hand. Who are you allowing to control your hand?

To clean a knife, use oil and a clean rag. The oil should also be used to lubricate the hinged portion of the blade. Never stick a knife in the ground, because doing so will dull the knife.



To open a knife hold it in one hand and with the thumb and forefinger of the other hand pull out the blade. To close a knife, hold the back edge of the open blade and close carefully.

Sharpen a knife by pressing the blade firmly on a sharpening stone. While holding the knife at a slight angle to the stone, move the knife in a circular motion. Keep pressure to the back of the blade. Turn the blade over and repeat the process in the opposite direction. Test the blades sharpness on a twig from time to time.



- Notes -

Hold a knife by grasping it firmly around the handle. Always cut away from you. Do not place your thumb on the blade.



When passing a knife, it is best to pass the knife closed. Have the person acknowledge receiving the knife by saying "thank you" before you release the knife.



When using a knife to cut a stick in two parts, make the cut at an angle. To cut a thick stick in two parts, make a "V" on top and then underneath.



To trim a branch, grasp the thick end and cut toward twigs. Remember, a good, sharp knife cuts evenly and smoothly.

- Notes -

*"For the word of God is living and sharper than any two-edge sword, penetrating as far as to divide soul, spirit, joints, and marrow; it is a judge of the ideas and thoughts of the heart."
(Hebrew 4:12)*

There may be times (emergencies, storms, backwoods areas, etc.) where electric power is not available. Therefore we would need to know how to use knives, axes and saws to cut wood to provide warmth, cook meals, and build shelters.

Sheath Knife

The sheath knife is not a necessary camp tool, but it is useful for heavier work such as cutting small branches or skinning and cutting up game and fish. It should always be carried in a sheath for safety. Sharpen it as you would a pocket knife blade.



Saws

Campers are encouraged to use a bow saw instead of an axe. Saws are safer and can usually be used to secure as much wood as you need. In fact, you can usually find enough dead wood on the ground or on dead trees to cut or break for your campfire. The type of saw that you use will depend on the need during your camping trip. When saws are not in use, cover the blade with a sheath. Saw sheaths can be purchased or made out of a split piece of PVC pipe. Replace saw blades when they become rusty or dull.

Camp Saws

- The trim saw is a smaller bow saw. It will do what is needed in cutting most wood used in a camp setting.
- The folding saw is similar to the trim saw in size but folds down for ease of handling and packing. The handle and back are usually made of aluminum and the back serves as the blade sheath. This makes the folding saw an ideal tool for backpacking.
- The bow saw is larger than the trim or folding saw. It will cut larger diameter logs easier. It is best suited for base camp work.



Trim saw



Folding saw



Bow saw

Sawbuck

Using the bow saw and a sawbuck is one of the easiest methods of cutting logs. The sawbuck holds the limb or log steady while it is cut. It is one of the best ways for younger boys to cut wood safely. Large amounts of wood can be cut in a short time.



Axes

An axe is generally used for cutting and splitting large logs needed around a base camp. In today's camping culture, large campfires are seldom used away from the base camp. Therefore, an axe usually is not needed except at the base camp. Those who handle and operate the axe must be trained in the safe use and care of the axe. It is recommended that safety glasses or goggles be worn.

Types of Axes

Hand axe or hatchet



Long handle, single-bit axe



Long handle double-bit axe *(For safety, this type should never be used on a campout.)*



"Does an ax exalt itself above the one who chops with it? Does a saw magnify itself above the one who saws with it? As if a staff could wave those who lift it! As if a rod could lift what isn't wood!" (Isaiah 10:15)

We should strive to remain as tools in God's hands and acknowledge Him in all that we do.

- Notes -

A tool in the right hand will do good. Our lives in God's hand will also do good and honor Him.

Axe Safety

It is a good idea to carry the axe in its sheath. To carry the axe without its sheath, hold the handle close to the head with the blade tilted away from you.



Pass the axe by grasping the handle at the head. Pass it with the blade away from you and the one to whom you are passing the axe. Have the person acknowledge receiving the axe by saying "thank you" before you release the axe. When the axe is not in use, leave it in the sheath or chopping block. Never leave the axe head lying exposed.

Sharpening an Axe

When sharpening an axe, hold it against a log or large piece of wood. File evenly along the blade. Turn the axe to expose the opposite side and repeat filing.



"Iron sharpens iron, and one man sharpens another." (Proverbs 27:17)

Using an Axe

When using the axe, always be sure you have plenty of room to swing the axe. Check overhead and to the sides by measuring with your axe. Hold the axe by the head and slowly swing the handle to be sure there is safe clearance on all sides. It is safer to kneel when using an axe.



*"If the axe is dull, and one does not sharpen its edge, then one must exert more strength; however, the advantage of wisdom is that it brings success."
(Ecclesiastes 10:10)*



Cut small branches by slanting the axe and make a "V" cut in the wood. If the wood is not cut in two on the first stroke, repeat with a cut at the opposite angle. Never strike wood with a straight cut.

Correct

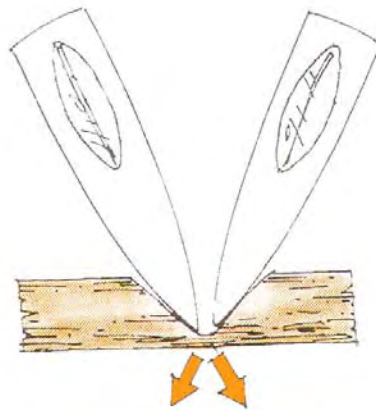

Incorrect

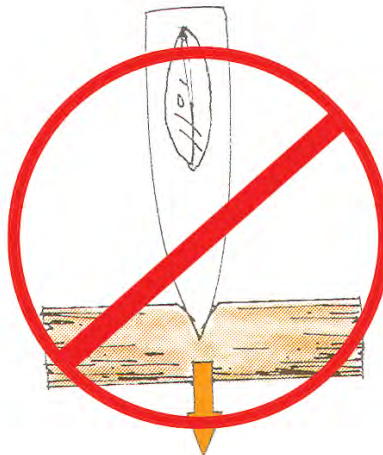

- Notes -

Many times trees are downed during natural disasters. Disaster relief teams provide assistance to home owners by helping them gain access to their homes by removing downed trees with the use of chainsaws. The adults that operate the chainsaws should receive safety training and wear the appropriate safety gear. Young men can assist the teams as walk-on volunteers and help by dragging limbs to the curb. Check with your state office concerning disaster relief training opportunities and volunteering to assist after a disaster.

"...the one who splits trees may be endangered by them." (Ecclesiastes 10:9b)

To Limb A Tree

To limb a tree that is down, stand on one side of the trunk and cut limbs on the other side. Swing the axe at the base of the limb with both hands.



Splitting Wood

When splitting small logs, place the log on the chopping block.



Bring the axe down firmly on the log.

If it doesn't split the first time, raise the axe and log and bring both down firmly on the chopping block.



When splitting larger pieces, place the log, standing on end, on the chopping block. Step back to allow room to swing the axe comfortably. Stand with feet apart. Recheck for overhead clearance.



Bring the axe back to your body, grasping under the handle near the head with right hand. Raise the axe with the right hand over your shoulder.



Lower the axe sharply with right hand slipping down on the handle stopping just above the left hand. Guide the axe as it falls. Let the weight of the axe head do the work. Do not force it.

- Notes -

Just as different tools are used for different jobs, we are given different Christian talents for different tasks. How can you use the talents God has given you to tell others about Jesus?

The safest way of splitting a log is by using a wedge and a large hammer or sledge. Never use the back end of an axe as a hammer.



Cutting up Logs

Unless the log is very heavy, peg it in four places. Stand with feet apart. Measure a distance for a comfortable, easy swing.

Slant the first cut. Guide the head in the proper place. Let the weight of axe to the work.

Make another cut to form a "V" shape. Make the "V" larger by cutting from side to side on the "V". Turn the log over and repeat on the other side until the log is cut in two.

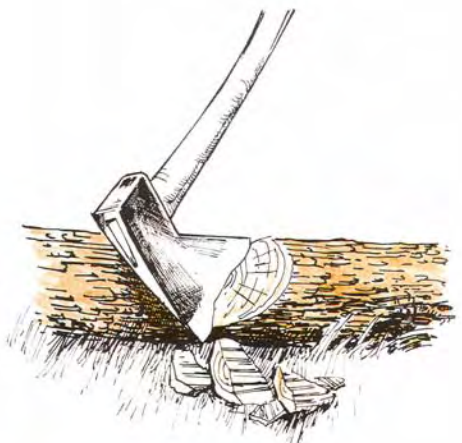
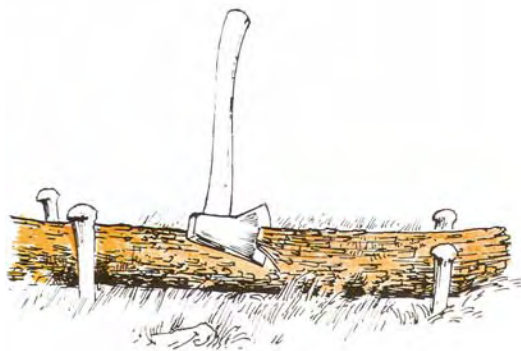

Other Tools

Other tools that may be useful in a camping setting:

- Limb lopper or pruning shears
- Rake
- Shovel
- Mallet or hammer
- Safety goggles and work gloves



Tool Rack

A camp tool rack can be constructed by lashing two poles or limbs close together between two trees. After using tools, always return them to the camp tool rack.



The tool rack is what all the tools are hung upon when in camp so they won't get stepped on, broken, lost or rusted. We should take care of and use the tools (talents) God has given us for His Glory.

Making a Canteen

You can make a handy canteen for a hike. You will need:

- A soft plastic water bottle
- A crew sock
- A strap, rope or cord for a handle (at least two feet long)



To make the canteen:

- Place the bottle into the sock.
- Tie the ends of the strap together using the fisherman's knot.
- Attach the strap to the bottle using a cow hitch or clove hitch.
- Now you have a canteen you can carry with you for a hike.



Using a Hammer

All hammers have two parts. A handle to hold the tool and the metal head to hit nails (or tent stakes). Some hammers have a metal head that is forked on one side to pull nails out of wood. This hammer is called a “claw hammer.”



Follow the steps below when using a hammer:

- For safety, wear eye protection.
- Hold the hammer by the handle.
- Hold the nail at the top (close to the head) with the point against the wood.
- Start the nail into the wood by tapping it lightly with the metal head of the hammer.
- When the nail can stand up without you holding it, remove your hand from the nail.
- Hold the hammer as far away from the metal head as you can. Strike the nail using the flat metal head. If you miss, try again. Hit the nail with the center of the metal head or you will bend the nail.

Can Openers

The can opener is a useful tool in Campcraft. There are many types of can openers and most operate in the same way. Be careful when opening cans because can openers often leave sharp edges.

The **turn-key can opener** is used by hooking the small gear under the rim of the can. Squeeze the handle to punch the small metal blade into the top of the can. Then turn the key clockwise to cut around the can. Lift the handles open when finished.



The **GI can opener** (known as a P-38) is a little different to use. Open the “wings” of the GI can opener as shown. Punch the small metal blade into the top of the can along the rim by hooking the rim of the can into the slot and pushing forward on the opener. Then slowly move the handle up and down while turning the can slightly. This action will move the blade around the top of the can.



Tool Storage Roll

You can make a tool storage roll to help organize your tools.

You will need:

- A piece of cloth 19 inches long and 10 $\frac{3}{4}$ inches wide. (You may use an old towel instead.)
- A small strip of cloth 14 inches long and $\frac{1}{2}$ inch wide.
- Thread and sewing needle. (Or get an adult to help you sew it on a sewing machine.)

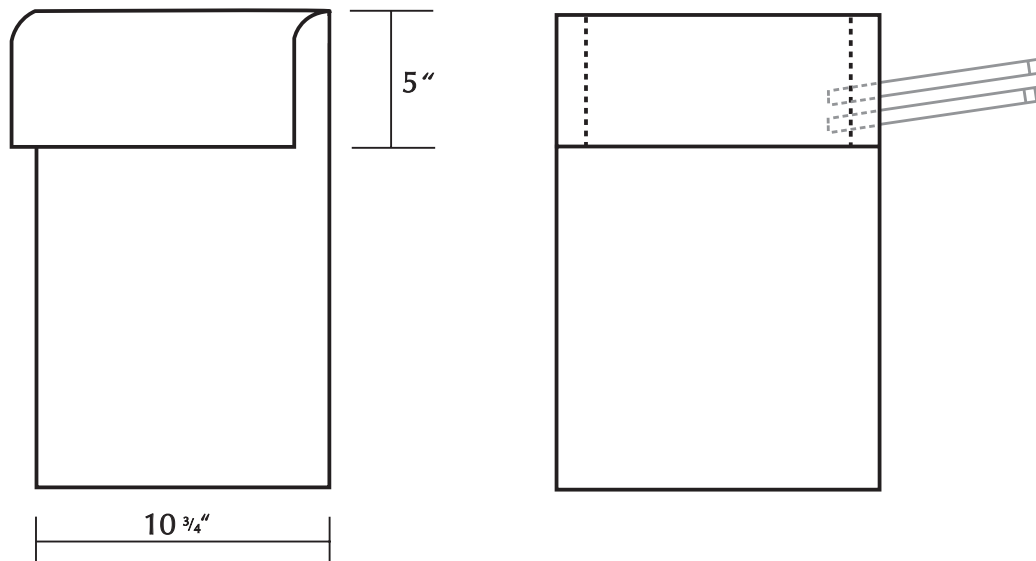

To make the tool storage roll:

- Fold one end of the cloth to form a 5 inch pouch.
- Fold the small strip of cloth in half. Insert it in the seam of the pouch. Sew the edges of the pouch $\frac{1}{4}$ inch from the edge.
- Next sew in the dividers. See drawing.
- Place tools in pouch and fold flap over. Roll them up and tie it all together with the strip of cloth.

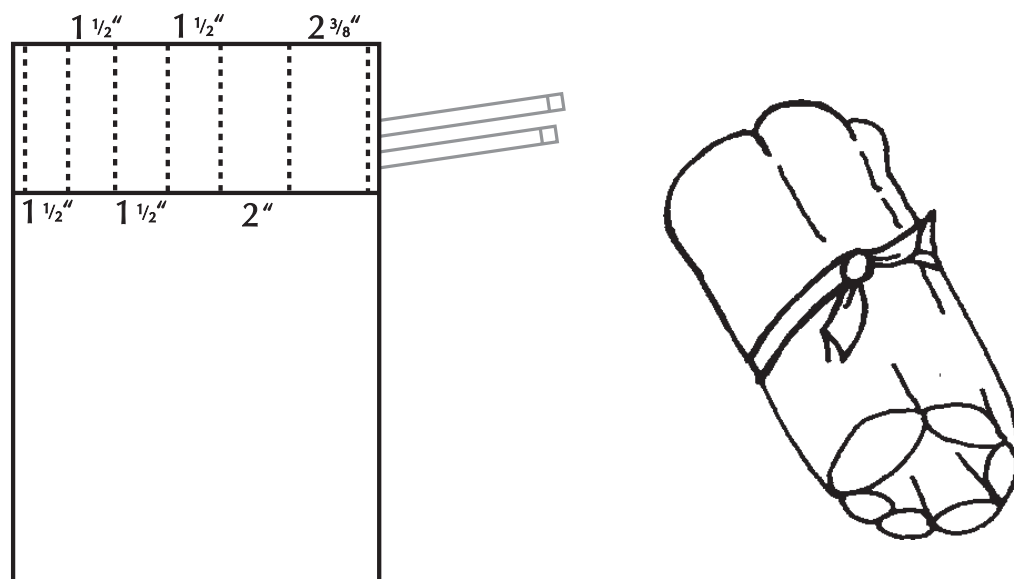

Tool Apron

You can make a tool apron to use in working on projects.

You will need:

- 1 yard of denim.
- 1 yard of flat lacing material.
- Thread and sewing needle. (Or get an adult to help you sew it on a sewing machine.)

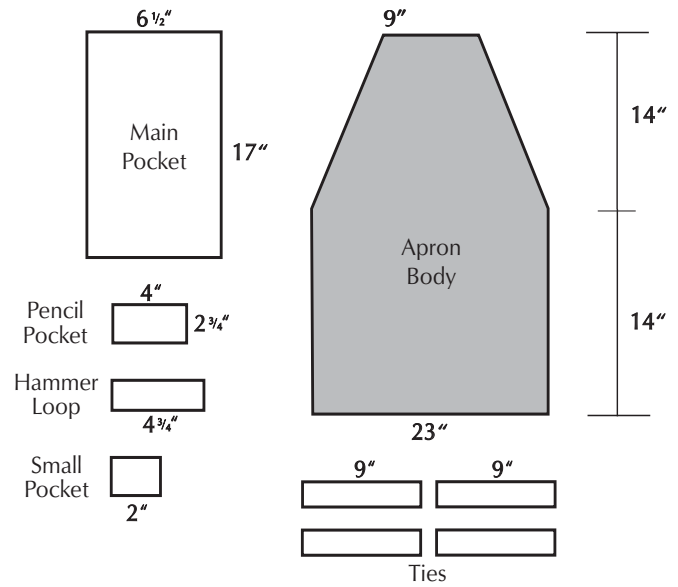

To make the tool apron:

- Cut each piece of the apron as shown.
- Fold the edges of the apron body 1/2 inch from the edge and sew.
- Fasten the ties to the apron body and stitch. Sew the hammer loop to the apron body. Attach the pencil pocket as shown. Position, pin, and sew the main pocket.
- Put the apron on. Adjust the lacing at the back of your neck. Tie it. Tie the waist loop in place, and you are ready to work.

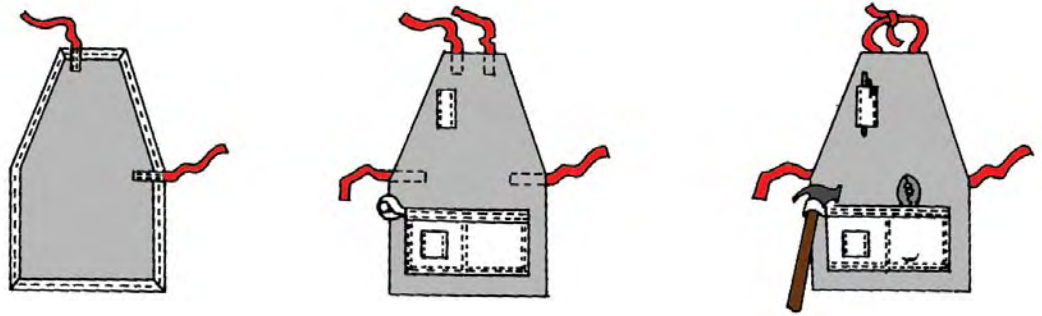

FIRE CRAFT



- ✓ Wood Fires
- ✓ Buddy Burners/Tin Can Stoves
- ✓ Charcoal Fires
- ✓ Camp Stoves

“Therefore, since we are receiving a kingdom that cannot be shaken, let us hold on to grace. By it, we may serve God acceptably, with reverence and awe; for our God is a consuming fire.” (Hebrews 12:28-29)

Wood Fires

An open campfire can be good and useful. You can use a campfire for warmth, light, cooking, drying, and fellowship. However, we need to be aware that the use of fires affect both conservation and environmental practices. Fires cause the scarring and blackening of the ground, rocks, and vegetation. Fires destroy dead branches and other vegetation that may be



used for shelter and nutrition for animals and plants. With the use of fires, there is always the danger of the fire spreading and destroying much of the surrounding landscape. Use only the ground space and natural materials necessary to make the fire that is needed. A small fire is best.

Care of Matches

- Use only large, wooden matches that will strike anywhere.
- Take care to keep matches dry and safe.
- Always handle matches in a safe manner and be sure a match is completely out before discarding.
- Waterproof a whole box of matches by pouring melted paraffin wax over them. A small match bundle can be waterproofed by dipping them into melted paraffin. Individual matches can be dipped into melted paraffin and then stuck into corrugated cardboard for storage. Melt paraffin in a “double boiler” type of pot (small can of paraffin sitting in a heated pot of water).
- Waterproof matches and waterproof match containers may be purchased at camping stores or be homemade.

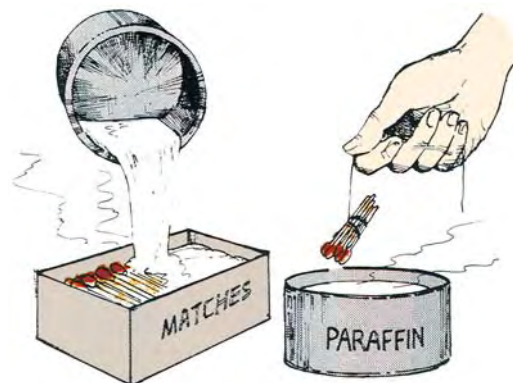

Fire Safety

Know these camp fire safety rules.

- Never play with matches.
- Never play around camp fire areas.
- Always use caution around any camp fire. Smoke and sparks from fires can cause irritation and burns.
- Know what to do in case your clothes catch fire. If your clothes catch fire immediately do the following:
 1. **Stop.**
 2. **Drop** to the ground and cover your face.
 3. **Roll** on the ground to put out the fire or smother with a blanket.
- Always supervise a camp fire.



Preparing a Fire Site

- Select an open area clear of overhanging branches and away from foot traffic.
- Clear a circle of burnable material large enough to keep the fire from spreading.
- If permissible and desirable, dig up a shallow amount of soil. Build the fire within the shallow hole. Save the soil for replacement after using the fire site.
- Secure an adequate wood pile for your needs before you start.
- Collect materials for preventing the fire from spreading - such as soil, a bucket of water, wet burlap bag or fire extinguisher.



*“And lets us be concerned about one another in order to promote love and good works, not staying away from meetings, as some habitually do, but encourage each other, and all the more as you see the day drawing near.”
(Hebrews 10:24-25)*

A bed of coals is used for cooking and providing warmth for campers. During a campout, safely remove one coal from the bed and set it near the campfire. After a few minutes the coal will begin changing from a bright red coal to a dim ember. When the ember is returned to the bed of coals, it will soon begin glowing again. When we remove ourselves from the body of Christ (the church), we gradually become cold. When we remain in fellowship with others, we help reflect God’s love and warmth.

Leave No Trace Fire Site

With the increasing awareness of environmental and conservation issues, many wilderness areas recommend and some require the use of “leave no trace” campfire sites. Keep fires small and use only enough wood to accomplish your purpose. Two such methods are as follows:

- **Mound Fire.** Bring a piece of plastic (a tarp, heavy plastic sheet or trash bag) and a small amount of sand or clay soil. Lay the plastic on the ground and make a pile or mound of the soil on the plastic. Build the fire on the top of the mound. After use, burn all wood to ashes, extinguish and broadcast the ashes over a wide area. Repack the sand or clay and plastic.
- **Pan Fire.** Make a fire pan out of an old portable barbecue grill, metal oil-drain pan, large disposable aluminum roasting pan, or metal trash can lid. Raise pan off the ground with rocks or logs, put sand in pan, then build the fire inside pan. After use, burn all wood to ashes, extinguish and broadcast the ashes over a wide area.



*“As Paul gathered a bundle of brushwood and put it on the fire, a viper came out because of the heat and fastened itself to his hand.”
(Acts 28:3)*

Gathering Firewood

Collect an adequate supply of the following types of fire-building materials:



Tinder - materials that catch on fire easily and quickly, such as small, dead twigs, soft wood shavings, pine needles, dead dry grass, “fuzzed up” peelings of cedar or birch bark and bundle of twine. Paper items should not be used because of their tendency to give off flying embers that are fire hazards.



Kindling - larger dead twigs and dry soft wood of finger thickness that break easily.

Fuel - large pieces of dry, dead wood from good sized branches up to logs. Break or cut to fit the size of your fire.



Types of Wood. Different types of wood are used for different purposes. Softwood (pine, cedar, spruce) is best for a quick, hot fire. Hardwood (oak, maple, hickory, ash, elm) is best for a long burning fire with lasting coals.

Starting a Fire

The Fire Triangle consists of the three elements needed for a fire: heat, air and fuel. To easily start a fire, use an "A" frame design. Form an "A" of small sticks on the ground with the open end of "A" toward the wind. Place a handful of tinder on the "A" frame. Strike match, cup hands to shield the match from the wind and hold the lighted match under the cross piece to ignite the tinder. Add more tinder and kindling slowly until the fire is burning with a good flame. Blowing or fanning gently will increase the flame. Slowly add fuel as needed, being sure that the fire can get plenty of a

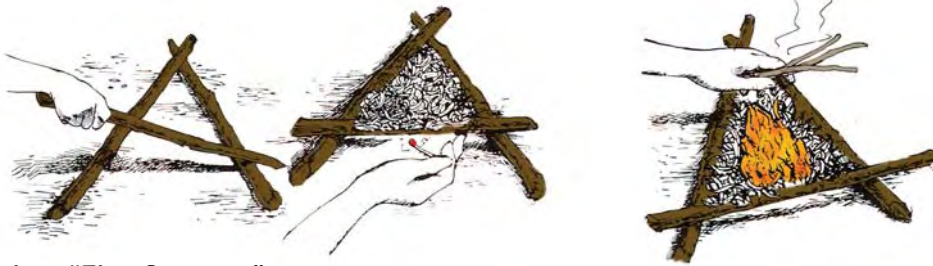

Using "Fire Starters"

Starting a fire when it is very windy or when the wood is wet can be difficult. "Fire starters," prepared ahead of time, make it easier to start a fire when it is windy or wet. Some "fire starters" to make are:

Cardboard - cut cardboard into 2-3 inch square pieces. Stack several pieces and tie together with a string. Dip the entire bundle into melted paraffin. To use, light the string or a corner of the cardboard.

Corn cob - dried corn cobs light easily.

Fuzz Stick - whittle a fuzz stick and drive into the ground. Arrange tinder around the fuzz stick like a tepee. Light the "fuzz".

Egg Carton - fill the cups of a cardboard egg carton with lint from clothes dryer or wood shavings. Fill each cup half full of melted paraffin. Break off a cup and place it with your tinder. Light the edge of the cup.

Candle Stub - use a short piece of a candle as a fire starter.

Newspaper - roll up a single sheet of newspaper and tie with string an inch or two apart along the length of the roll. Cut between the strings and dip in melted paraffin. Place under tinder and kindling to light.

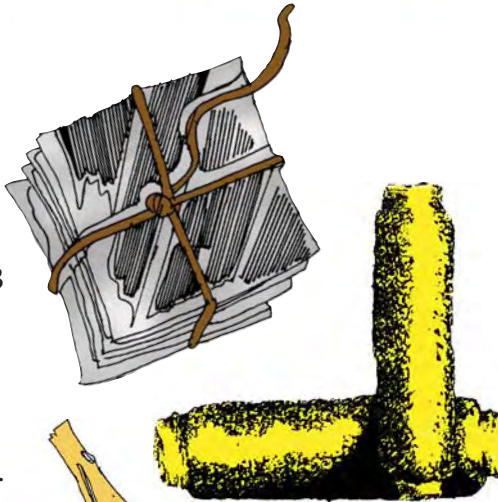

*"Without wood, fire goes out; without gossip, conflict dies down."
(Proverbs 26:20)*

Commercial Fire Starters

There are many different commercial fire starters that can be purchased from retail stores. Different types of camping will often determine which fire starters to take. A prepared camper will carry more than one fire starter to be able to start a fire quickly in adverse conditions. **Never use Coleman fuel or gasoline to start a fire because of their explosive properties.**



Types of Fires

Different types of fires are used for different purposes :

Warmth and Light

Tepee Fire - gives a quick hot fire for warmth and light. Build a tepee of branches around the tinder and kindling. Add sticks of same length, leaving plenty of air space.



Criss-Cross Fire (Ceremonial Fire) - useful for warmth and light for a group. Build a tepee of soft wood kindling and place larger logs or split wood around the tepee. Criss-cross more logs over the first layer. Continue building layers of logs to about two feet high. Place tinder and kindling on highest layer and finish with smaller branches or split wood. Light the fire at the top and falling coals will light the tepee at the bottom.

Reflector Fire - build a wall of rock or green logs behind and on the sides of the fire to reflect heat. This makes a good wind break and the rocks continue to radiate heat even after the fire dies down.



Cooking Fires

Hiker's Fire - build a small fire and suspend a stout branch over the fire to hold a pot. Anchor the branch with rocks.

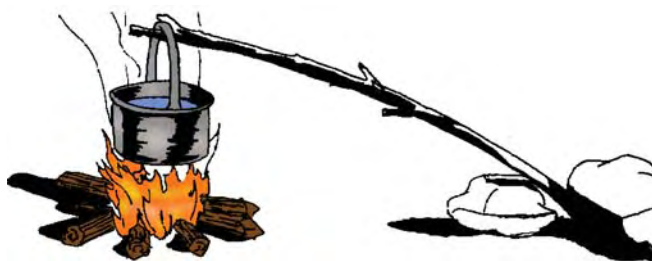

Hunter's Fire - use green logs for sides spaced apart in order to support the cooking pots. Line up logs with the wind and build the fire between the logs.

Trench Fire - is the safest in windy weather and most comfortable in hot weather. Dig a trench, lined up with the wind, slightly smaller in width than your cooking pots and to a sloping depth of 6 to 12 inches. Build your fire in the trench and let it burn down to coals. Place the pots over the coals, with sides of trench supporting the pots.



Keyhole Fire - a variation of the trench fire that allows for longer cooking times with a continuing supply of coals. Dig a round hole or outline a circle in which to build your fire. Dig or outline a trench extending from this circle, making the trench slightly narrower than your pots and pans. (Metal cross pieces can be used to support the various cooking containers.) Keep adding wood to the fire and as it burns into coals, rake the coals into the trench for a continuing heat supply for cooking.

Reflector Fire - build a log or aluminum foil wall behind your fire to reflect heat forward. Place a reflector oven on the opposite side to provide a baking surface.



Beanhole or Imu (E-mu) Fire - dig a large hole with plenty of room for a pot. Build a fire across the top. As the fire burns, coals will drop into the hole. Add kindling and fuel until the hole is filled with hot coals. Remove enough coals for the pot to fit into the hole. Place the rest of the coals over and around the pot. Cover with damp burlap and pack dirt on top. After four to six hours, your meal is ready.

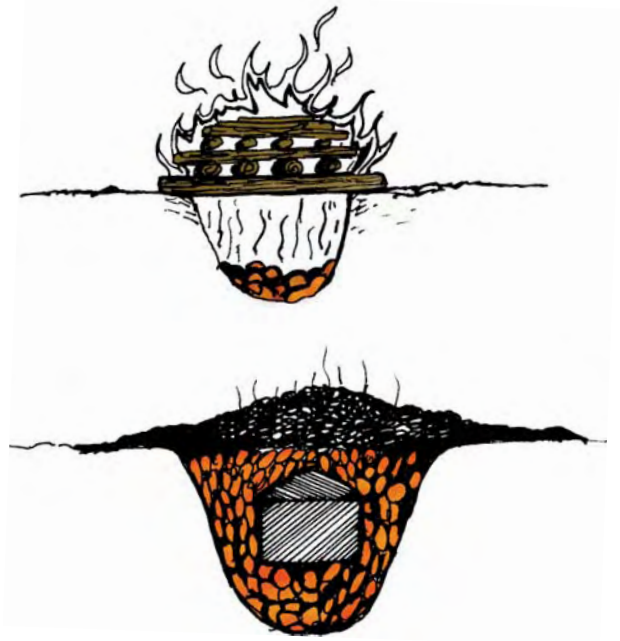

Putting out a Fire

To put out the fire:

- Sprinkle water and/or dirt onto fire.
- Spread out the logs and coals.
- Sprinkle again.
- Carefully test for heat by running hands over the fire site to be sure fire is out.
- Repeat sprinkling until no heat is felt.
- Replace any soil and sod removed.

A good camper leaves the site as he found it, or even better. Try to leave the site without a trace that you have been there.



Buddy Burner and Tin Can Stove

- Notes -

Buddy Burner

To supply fuel for your tin-can stove, make a "Buddy Burner":

- Secure a small short metal can, such as a tuna fish can. Avoid using thin-walled or aluminium cans.
- Cut a strip of corrugated cardboard shorter than the height of the can. Loosely coil the cardboard strip and place in the can. An alternative method that produces a more controllable flame with much less smoke and soot uses two pieces notched to form an "X".
- Pour melted paraffin into the can and fill to just below the top edge of the cardboard. Allow it to cool.



Tin Can Stove

To make a cooking surface (stove) for your buddy burner:

- Secure a #10 metal can and cut the top completely out.
- Using tin snips, make two cuts wide enough apart and long enough to insert the buddy burner. Bend up the cut piece. Caution - sharp edges will be exposed, use leather gloves to protect your hands.
- Use a punch can opener to punch two or three air circulation holes at the top of the can on the opposite side of the square.

To use your tin can stove:

- Light the cardboard and place the Buddy Burner under the stove.
- Place food to cook on the top surface of the can, making sure the can is level. If using the stove more than once, cover the top with aluminum foil each time you cook.
- Cooking temperature and speed can be adjusted by turning the open square toward or away from the wind.
- If large enough, the bent piece can be used to toast your bread.
- Extinguish the burner by covering with a nonflammable object and allow to cool.

When using your stove, handle carefully because it is very hot and the inside of the can could be very black and sooty.



"For God so loved the world in this way: He gave His One and Only Son, so that everyone who believes in Him will not perish but have eternal life." (John 3:16)

- Notes -

*“So that the genuineness of your faith – more valuable than gold, which perishes though refined by fire – may result in praise, glory, and honor at the revelation of Jesus Christ.”
(1 Peter 1:7)*

Charcoal Fires



Many areas of the country will not allow open wood-burning fires and sometimes weather conditions will require temporary burn bans. Always check the current fire regulations for your camping area prior to leaving. Charcoal fires, however, are usually allowed for cooking.

Small, adequate charcoal stoves may be purchased at camping or hardware stores. You can make your own by using a #10 or larger metal can:

- Cut one end completely out.
- Take a punch type can-opener and punch holes around the bottom and top for air circulation.
- Place charcoal in the bottom of the can, use a small amount of charcoal lighter and carefully light with a match.
- Place an unpainted mesh wire square or small grate over the top for grilling or to hold pans.
- Use pliers to handle hot grates and pans.



Hobo Stove

Allow at least 15 minutes for the coals to be ready after lighting. Chemical starters may be used but are very flammable and dangerous. Use only with care and supervision. The fire can be put out by sprinkling water on the coals.



Charcoal Starter

Camp Stoves

Camp stoves are useful and desirable when:

- There is concern about conservation practices and environmental damage (i.e.. depletion of wood, fire site scars, damage to trees and other plants, damage to animal habitats).
- An open fire would be dangerous because of windy or very dry conditions.
- Land managers prohibit open campfires. Check a particular area's fire-building rules before going.
- Cooking for a large group on an extended camp outing.
- A more reliable source of heat is desired anywhere, anytime and in any weather.

There is a variety of camp stoves using various fuels available from sporting goods stores.

Stoves for Base Camp Use

These types of stoves usually have 2 or more burners, are compact, can be easily closed up and carried, and have back and side wind-screens. They are too heavy and bulky for backpacking use.

Fuels for these stoves include:

- **Propane** - efficient and safe. Comes in pressurized canisters that will last 4-6 hours. Refueling is as easy as replacing the canister. They are dependable at high altitude and in very cold weather.
- **Butane** - comes in pressurized canisters lasting 3-4 hours. Refuel by replacing the canister. These are not dependable in very cold temperatures and lose efficiency as the canister begins to empty.
- **Coleman® Fuel** - very volatile. Must be carried, stored and used with caution. Refuel by filling stove's fuel tank. The fuel tank must be pumped to pressurize for use.

Always dispose of empty fuel canisters or cans by carrying them out to a designated disposal site.



Stoves for Backpacking

These types of stoves should be light, compact, easy to use and refuel. They may use propane or butane in pressurized canisters which attach directly to the burner. Some stoves also use Coleman® fuel. Metal containers of fuel must be carried for refueling the stove's tank.



For more basic, individual cooking - use a small, light, foldable pack stove with a can of Sterno® for fuel. These can be used with an individual cook/mess kit.

Choosing A Stove

With so many brands of stoves on the market, how can you determine which stove to buy? The following list of questions can help you in evaluating the qualities of a stove. The more questions that you answer “yes” to, the more desirable the stove.

- Does the stove have a good reputation for durability and handling?
- Is the stove already pre-assembled?
- Is the stove free of sharp protruding edges?
- Is the stove wider at the base than at the pot support?
- Can the stove accommodate a pot large enough to feed four people?
- Will the stove start without priming?
- Does the fuel tank remain cool while the stove is burning?
- Is there air space between the flame and the bottom of the pot when the flame is on high?
- Will the stove operate above 6000 feet altitude?
- Will the stove operate in below freezing temperatures?
- Can you justify the stove’s weight versus its dependability and cost?
- Does the stove burn multiple types of fuel?



Safety Factors to Consider with Camp Stoves

- Read and follow the manufacturer’s instructions for use and safety.
- Let stove cool before refueling or putting away.
- When replacing fuel canisters, be sure all connections are tight and have no leaks.
- Be sure stove is stable and will not tip over.
- Avoid flash and flare-up when lighting by following manufacturer’s guidelines.
- Keep all stove parts clean and lines and burners unclogged.
- Cap and store fuel cans or canisters in a safe place away from stove or heat.
- Use stoves outside - never in tents.
- Never use gasoline as a stove fuel. It is too dangerous.
- Use pots and pans the right size for your stove.
- Test the stove and know how to use it before taking it on a camping or backpacking trip.
- Even when empty, keep fuel containers away from heat.

Factors Influencing Stove Efficiency

- Altitude - the higher the altitude, the longer the cooking time.
- Temperature - very cold temperatures reduce efficiency.
- Wind - increases cooking time by blowing flame away from pot.
- Pot Lid - covered pots cook faster.
- Amount of fuel - full tanks heat faster than "almost empty" tanks.
- Type of food - "add hot water" foods are faster than "simmer an hour" foods.
- Distance between the flame and the pot - the closer the better, but the flame should not touch the pot.
- Size of flame - wider flames cook faster.

Tips on Firecraft

- When putting out a fire, remember the Fire Triangle. Removing any one of the three elements will put out the fire.
- Remember to keep the wood pile covered to protect from moisture.
- If your logs are wet, use an axe or mallet and wedge to split one. The inside of a split log will often be dry and should be easier to light and burn.
- Never leave an area until you have verified the fire is completely put out.
- Check to see if any burn bans are in affect and if any fire permits are needed.



COOKING

6



- ✓ When Do We Eat?
- ✓ Menu Planning
- ✓ Cooking Methods
- ✓ Dutch Oven Cooking
- ✓ Trail Snacks
- ✓ Cooking Devices
- ✓ Cooking Tips

- Notes -

"I am the bread of life," Jesus told them. "No one who comes to Me will ever be hungry, and no one who believes in Me will ever be thirsty again." (John 6:35)

"Then the LORD said to Moses, 'I am going to rain bread from heaven for you. The people are to go out each day and gather enough for that day. This way I will test them to see whether or not they will follow My instructions. On the sixth day, when they prepare what they bring in, it will be twice as much as they gather on other days.'" (Exodus 16:4-5)

The children of Israel were told to gather enough manna for one day. But on the sixth day they were to gather enough for two days. God would provide none on the Sabbath. God provided the children of Israel's need by supplying manna and quail. We come to a closer relationship with God when we realize He can and does supply our needs.

When Do We Eat?

Why does it seem that outdoor activities not only improve the taste of the food prepared outdoors, but also increase the appetite of the camper? Outdoor cooking is not only a pleasant and fun activity, but it can also be an important skill to have in times of necessity such as power outages and outdoor adventures. Cooking takes skills from several different areas of campcraft training and puts them to use. Since information will be covered in different areas, this section will focus primarily on outdoor cooking.

Menu Planning

Meal planning may not seem very important, but it most certainly is a vital part of any outdoor cooking experience! As our society has changed, so have the eating habits of our campers. A generation ago, breakfast would probably have included some type of breakfast meat with eggs, accompanied with biscuits or toast. Today's breakfast, (if eaten at all), may be a bowl of cold cereal, a doughnut or a toaster pastry. Lunch may be a sandwich or fast food and dinner may be carry-out or something out of the freezer that is cooked in the microwave oven. Menu planning is important not only to provide something to eat, but also to expose campers to some new food items that they may have never eaten before. At the end of this section, you will find a chart that will help you to plan your menus.



Also, most food items are now labeled with the serving size and number of servings per package. You should check these serving sizes to see how they match-up with the age of campers that you have in your group.

Now let us look at some possibilities for our meals. You will find suggestions and recipes included in some of these sections. Although there is an abundance of ideas that can be easily used in outdoor cooking, these are just some simple ones to get you started. With the availability of the Internet, there are many recipes and tips about cooking that can be downloaded.



Breakfast

The morning meal is very important for campers since it prepares them for the day's scheduled activities.

Here are some ideas for breakfast: Bacon, sausage, or ham and eggs, breakfast burritos, cereal (hot or cold), biscuits or toast, sausage gravy, French toast, pancakes, cinnamon rolls or doughnuts.



- Notes -

Just as we need to start each day with food for our bodies, we should also start the day with spiritual food - prayer, Bible study, singing and praising God.



Lunch

Lunch in camp may be different from lunch on the trail. In camp this may be a larger meal that requires more preparation. While on the trail it may be more of an expanded snack and rest time.

Here are some lunch ideas for in camp: One pot meals such as stews, chili, chicken and dumplings, pizza, beans, vegetables, tacos, fajitas, sloppy joes, and sandwiches. Dessert could include cobblers, cakes, cookies, or puddings.

Some suggestions for lunch on the trail could include dried meats, canned meats, cheeses, peanut butter, crackers, sandwiches, dried fruit, nuts and chocolate.

Dinner

Dinner usually provides an opportunity to expand the menu. For the camper on the trail, this may be the big meal of the day. Dinner meals provide an opportunity to try some different methods of cooking that may not be practical for other times during the day.



Some popular ideas for dinner include foil burgers, one pot meals, chicken and rice, barbecue, spaghetti, lasagna and meat pies. Desserts could include cobblers, cakes, pies, cookies or puddings. Some of these dishes will be discussed later in this section.

- Notes -

“Therefore, when Jesus looked up and noticed a huge crowd coming toward Him, He asked Philip, ‘Where will we buy bread so these people can eat?’ He asked this to test him, for He Himself knew what He was going to do. Philip answered, ‘Two hundred denarii worth of bread wouldn’t be enough for each of them to have a little.’ One of His disciples, Andrew, Simon Peter’s brother, said to Him, ‘There’s a boy here who has five barley loaves and two fish—but what are they for so many?’ Then Jesus said, ‘Have the people sit down.’ There was plenty of grass in that place, so they sat down. The men numbered about 5,000. Then Jesus took the loaves, and after giving thanks He distributed them to those who were seated; so also with the fish, as much as they wanted. When they were full, He told His disciples, ‘Collect the leftovers so that nothing is wasted.’ So they collected them and filled 12 baskets with the pieces from the five barley loaves that were left over by those who had eaten.” (John 6:5-13)

Special Items

Many times the most vivid cooking memory from a camping experience is not a meal that was prepared, but some special item that was cooked. This could be a cobbler that was cooked on the evening campfire, the traditional s’mores (roasted marshmallow with a chocolate bar square and two graham crackers), biscuit dough wrapped around a green limb and cooked over the campfire and eaten with jelly or honey, banana boats, ice cream made in two coffee cans, pineapple upside-down cake cooked in a Dutch oven, or some other special treat.



Cooking Methods



There are many methods of cooking that can be used while camping. Most are best suited for specific types of menu items. As you gain experience with your cooking, try some of the more challenging methods of preparing food!

Boiling

Boiling is one of the simplest methods of cooking. As you have learned in Firecraft, cooking is usually done best over coals instead of a flame. When cooking over a fire, it is good to have some type of device to hold the pan up off of the coals. This may be some type of metal frame that will support your pan. Rocks should be avoided as they may become hot and fracture, sending out hot rock fragments. Many campers use a bar or rod over the fire which is supported by two uprights. Hooks are normally used to suspend the cooking pots over the fire. *Hint! If bar soap is rubbed on the bottom of your pan before you use it for cooking, it will be easier to cleanup after you are finished.*

Boiling is used for heating water, making coffee and preparing a wide variety of foods such as rice, pasta, potatoes, corn-on-the-cob, beans and one-pot meals.

One item that is easy to prepare is hot chocolate. With the availability of instant hot cocoa mix, it is simply a task of heating water and mixing it according to the package directions. There are recipes available for making your own mix if you desire.

- Notes -

Camp stew is a one pot meal that is very easy to prepare. There are many recipes available, but here is one that is quick and simple. Break up one pound of ground beef and brown it in at least a 2 qt. saucepan. After draining any grease, empty two 16 oz. cans of mixed vegetables, one 16 oz. can of diced tomatoes, one small diced onion and one 16 oz. can of water. Season to taste with salt and pepper and any other seasonings that you want to use. Cook over medium heat for 30 minutes. This should feed four to six campers.



Another one pot meal is chicken and dumplings. Empty a small can of cream of chicken soup into a saucepan. Add a soup can of water or milk and a small can of boned chicken. Heat to a boil, open a tube of canned biscuits and pinch each biscuit into about six pieces and drop into the boiling liquid. Stir occasionally. After all biscuits have been put into the liquid, continue to cook until the dough is done (approximately five to ten minutes). This meal should feed about three campers.



“When Elisha returned to Gilgal, there was a famine in the land. The sons of the prophets were sitting at his feet. He said to his attendant, ‘Put on the large pot and make stew for the sons of the prophets.’ One went out to the field to gather herbs and found a wild vine from which he gathered as many wild gourds as his garment would hold. Then he came back and cut them up into the pot of stew, but they were unaware of what they were. They served some for the men to eat, but when they ate the stew they cried out, ‘There’s death in the pot, man of God!’ And they were unable to eat it. Then Elisha said, ‘Get some meal.’ He threw it into the pot and said, ‘Serve it for the people to eat.’ And there was nothing bad in the pot.”

(2 Kings 4:38-41)

Frying

Frying is often used in outdoor cooking. The traditional cast-iron skillet has long been a staple around the campfire. With the trend away from fried foods, this method is probably not as popular as it once was. There is also a issue of safety when dealing with hot grease, especially around younger campers.

Some of the more common menu items that are still prepared by frying include fried chicken, chicken fried steak, fried fish, fried potatoes, bacon and sausage.

Here is a simple recipe for fried chicken or steak. Place about one inch of vegetable oil or shortening in your skillet. Heat to medium high heat. While the oil is heating, prepare your meat. Season to taste with salt and pepper, dredge in all-purpose flour, dip into a mixture of one beaten egg and one-half cup of milk, dredge again in the flour, and then carefully place in the hot oil. When the first side is brown, turn over and brown on the other side. The thicker the meat, the longer it will take to cook. Always make sure that the meat is cooked thoroughly.

To cook fish, a common recipe is to season the fish with salt, dredge in yellow or white corn meal (or a mixture of both), and place in hot oil. Turn over once and cook on the other side. The thickness of the fish will determine how long it will need to cook.



Grilling / Toasting

The sight, sound, and taste of grilled foods has made it a very popular method of cooking. A variety of food items can be grilled over an open fire, charcoal, or a gas grill.

Grilling is not just limited to cooking meats over a fire, but can include preparing toast or grilling vegetables. For grilling, it is better to cook over coals than an open flame. For really primitive camping, try placing a cut of meat, such as a steak, directly on the coals. After cooking on both sides, brush off the small amount of ash and enjoy. However, for most grilling it would be better to have some type of metal grate that can be placed over the fire. It is simple to place a cut of meat such as a steak, pork chop, piece of chicken, hamburger patty or even a wiener on this grate and cook until it is done. There is a variety of seasonings on the market that can be used to enhance the flavor.

Another option is to slice small squash or zucchini in half, brush with olive oil or vegetable oil, season with some type of mixture of salts and seasonings, and then place them on the grill with a medium heat range. Before they start to burn, turn them over and cook on the other side. Other types of vegetables like tomatoes, onions, or peppers can be used.



Toasting of food over a fire has been around for a long time. One of the most popular and simplest method of cooking is to toast marshmallows or roast wieners over a fire. However, marshmallows can become very hot and easily catch on fire. Wieners should be roasted using some type of device that will not get hot. Metal coat hangers can get hot and may have hazardous coatings. Use caution and be sure to remove any coatings prior to using.

- Notes -

Jesus cooked breakfast for the disciples on the seashore.

“When they got out on land, they saw a charcoal fire there, with fish lying on it, and bread. ‘Bring some of the fish you’ve just caught,’ Jesus told them. So Simon Peter got up and hauled the net ashore, full of large fish—153 of them. Even though there were so many, the net was not torn. ‘Come and have breakfast,’ Jesus told them. None of the disciples dared ask Him, ‘Who are You?’ because they knew it was the Lord. Jesus came, took the bread, and gave it to them. He did the same with the fish.” (John 21:9-13)

- Notes -

It is difficult to cook food properly on open flames. You need a good bed of coals to ensure consistent heat so your food is cooked properly. Preparing our lives to serve God is the same way. We need to be steady and consistent - not flaring up and cooling off.

A slice of bread can be held on the end of a stick and toasted. Also canned biscuits or biscuit dough can be formed into a long pencil shape, wrapped around a green limb, and held over the fire and rotated until done and brown. It then can be pulled off of the end of the stick and eaten with butter, jelly, or honey.

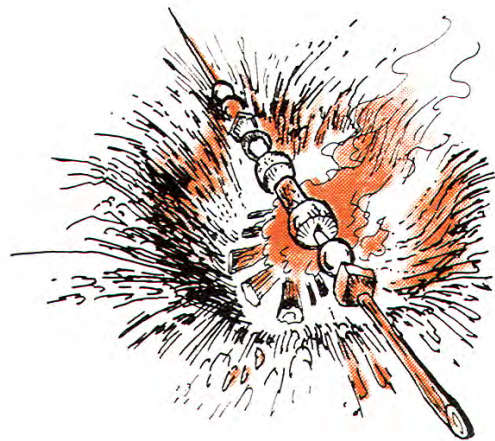

Spit Cooking

No, this is not what you might think! Probably the very first tool for cooking that someone used was a green limb held over a fire with a piece of meat on it. This allows for cooking without getting so close to the fire. A variety of foods can be cooked with this simple method. Small pieces of meat alternated with pieces of vegetables such as onion, tomato, pepper, squash, zucchini, or snap peas can be skewered on rods, bamboo sticks, or green limbs. Season these however you like and place them over the fire, rotate frequently, and cook until done.

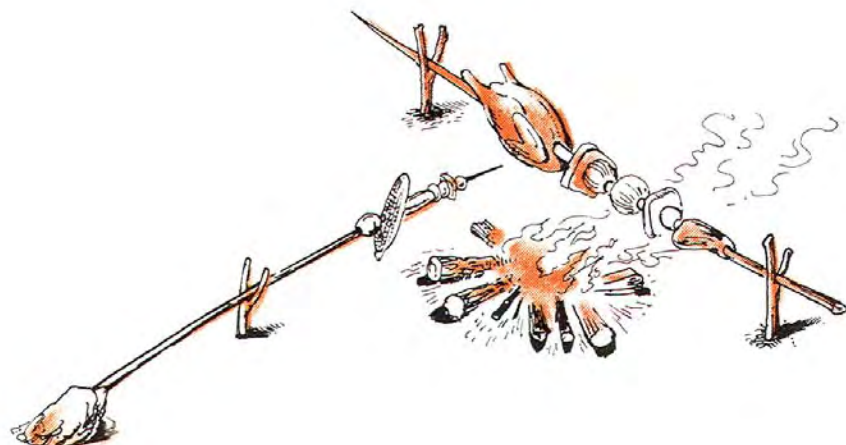

Griddle

A griddle is basically a solid piece of heavy metal (aluminum, steel, stainless steel, or cast iron) that can be placed across a fire, allowed to get hot, and then used for cooking. This process has been used for years in restaurants and cafes. These griddles range from manufactured griddles with gas burners



underneath, to plow discs, to just a piece of metal thrown down on a fire. A skillet without grease or even a camp Dutch oven lid turned upside down will give the same effect as a griddle. There is a wide range of items that can be cooked with this type of cooking equipment. One good suggestion to remember when using a griddle is to use a light coating of oil or margarine to help prevent sticking and to aid in browning.

This method is most often used for breakfast. Bacon, sausage, ham, eggs, hash browns, toast, pancakes and French toast are just a few of the items that can be cooked on a griddle for breakfast.

For lunch or dinner you might cook grilled cheese sandwiches, hamburgers, pork chops, steaks, chicken, garlic toast, or Texas toast, just to name a few. Have you ever had a grilled peanut butter and jelly sandwich? How about a "fluff-n-nutter" sandwich? Toast two slices of bread, coat one piece with peanut butter, coat the other piece with a layer of marshmallow cream, then put the two coated sides together, cut into halves, share with a friend and enjoy.



Be willing to try new foods and different ways of preparing foods. As we "carry the message around the world" we might find ourselves encountering different menu items that we may not be accustomed to eating. Being willing to try different foods may open the door to sharing the message of Christ with other cultures.

- Notes -

"Again He said, 'What can I compare the kingdom of God to? It's like yeast that a woman took and mixed into 50 pounds of flour until it spread through the entire mixture.'" (Luke 13:20-21)

Baking powder is what makes biscuits rise and taste so good. God's word is the baking powder in our lives. It makes our hearts and souls rise up and give thanks, so that we will be ready to serve Him as the risen Saviour.

Baking

Probably one of the most challenging ways to cook outdoors is baking. Since baking usually involves surrounding what you are cooking with heat, the challenge is to get the proper heat all of the way around the pot or pan. More outdoor baking is probably done in a Dutch Oven than any other way. Dutch Oven cooking will be discussed in a later section.

Generally the most popular baked items are breads or cakes. Most of the time these items will contain flour or corn meal and some type of ingredient, such as baking powder, baking soda, or yeast, to make them rise. Most baking will require indirect heat. This is usually accomplished by having the item being baked placed to the side of the fire.



One of the methods that has been used successfully is a reflector oven. A reflector oven utilizes metal to direct the heat back toward the item being cooked. This can be accomplished by using one piece to hold the pan, one angled up from the bottom and one angled down from the top. This will create a wedge shape that will maximize the heating and baking effect of the fire. Sometimes large rocks or green logs can also be used to direct the heat to the side of the fire where you are baking.

Baking is also done with aluminum foil. To bake an apple, core the apple, fill the core with a teaspoon or two of sugar and a little cinnamon, wrap the apple loosely in heavy duty aluminum foil, and place in coals. Cook for 20-25 minutes and check for doneness. When it is done, unwrap and enjoy. Onions can also be baked in much the same way. Peel and core the top and bottom of the onion, salt (Cajun seasoning works really well), and place a teaspoon or two of butter on the top of the onion. Wrap loosely in foil and place in the coals. Start checking for doneness after about 25 minutes.

Another foil baking item is a cupcake baked in an orange half. Cut the top off an orange, carefully scoop out the orange and eat. Fill the empty orange about one-half full of prepared cake or muffin mix, replace the top, loosely wrap the orange with foil and place on a level spot in the coals. Check after 15-18 minutes for doneness. If not done, continue for a few more minutes.



Aluminum Foil Cooking

Aluminum Foil Cooking has become a very popular method of cooking. It not only requires less equipment and setup, but also the cleanup is much simpler and quicker. Foil can also be used to form small bowls, pans and other utensils as well as for storage and protection of food items. It is often used in connection with other cooking styles such as lining of Dutch Ovens or covering a grate over a campfire. There is a type of aluminum foil presently on the market that is a super heavy-duty strength. It is more costly, but will probably work more satisfactorily for outdoor cooking.



- Notes -

*"Suddenly, an angel touched him. The angel told him, 'Get up and eat.' Then he looked, and there at his head was a loaf of bread baked over hot stones and a jug of water. So he ate and drank and lay down again. Then the angel of the LORD returned a second time and touched him. He said, 'Get up and eat, or the journey will be too much for you.' So he got up, ate, and drank. Then on the strength from that food, he walked 40 days and 40 nights to Horeb, the mountain of God."
(1 Kings 19:5-8)*



A baked potato is simple to prepare in the campfire. First, wash and scrub the potato, then pierce it several times with a fork, rub the outside of the potato with a small amount of butter and then wrap in aluminum foil. The potato can also be placed inside a clean, empty can and then wrapped with foil. Place in the fire and cook for about 45-50 minutes, rotating occasionally. If the potato is not soft when it is mashed, leave it on the fire for a few more minutes. After determining that the potato is done, let it cool for a few minutes before serving. Serve with butter, salt and pepper, and any other topping that you want. Sweet potatoes can also be prepared in the same way.

Foilburgers

"Foilburgers," "trailburgers," "hobo dinners," "silver turtles" and other names are given to the same basic meal that can be prepared and cooked in the campfire. For our purposes we are going to refer to them as "foilburgers." The basic concept is a combination of meat, vegetables, and seasonings all sealed up in aluminum foil and then cooked directly in the campfire. The number of packets that you will be cooking at one time will determine the size of fire that you will need. A good hot bed of coals is much better for cooking than a fire that has a lot of flame and not many coals. It may be necessary to start your fire one to two hours earlier than when you plan to cook in order to produce an adequate amount of coals.

RECIPE

Here is what you will need to prepare each meal:

- 1 piece of heavy weight aluminum foil approximately 18" x 18"
- 1/4 pound of raw hamburger meat flattened out to 4 inches in diameter
- 4 slices of raw potato approximately 1/4 inch thick
- 1 slice of raw onion approximately 1/4 inch thick
- 1/2 raw carrot cut long ways into quarters
- 1 teaspoon of margarine
- 1 Tablespoon of water
- Salt and pepper to taste

It is easier to assemble this dinner if you can work on a flat surface like a table top. Lay out the foil with the shiny side to the inside. Next place the carrot strips in the center of the sheet. Salt and pepper each layer as you put this together. Now lay the hamburger patty on top of the carrots. The onion slice is next followed by the potato slices. Top with the margarine. Bring two opposite sides of the foil up and together. Make a good seal by folding the foil seam over several times. Don't fold the foil down tight against the packet, but instead, leave a little room for expansion.



Now fold in the corners on one of the remaining ends and then start folding the small section toward the center of the packet. After pouring the tablespoon of water into the packet, seal the other end in the same manner as the first end. The water will generate steam which will help to cook your meal. Be sure that all of the folds create a tight seal all of the way around your foilburger.



Now to cook our meal. Locate an area that has a good bed of coals and place your dinner directly onto the coals. If you have a large fire it is sometime best to move some of the coals to the outside of the fire and place your foilburger on them. A long handled shovel works well for moving coals and placing foil burgers. If desired, coals can also be heaped on top of the dinner to speed up the cooking process.

Cooking time is somewhat flexible depending upon conditions. As a general rule, check the dinner after about fifteen minutes. If it is not done, return it to the fire for another five to ten minutes or until it is done. When the dinner is ready to eat, try to dust off as much ash as possible (a whiskbroom works well for this) and support it with some type of plate.



*"Every living creature will be food for you; as I gave the green plants, I have given you everything."
(Genesis 9:3)*



Be very careful when opening the foil because there will be a lot of steam released. The food can be removed to a plate or open back the foil and eat it directly from the packet. A word of caution: the food will be very hot!

The variations of this meal are only limited by your imagination! A variety of foods can be cooked in this manner. There are all types of variations to this meal. Here are a few things that can be added or substituted:

Beef steak
Chicken
Pork chop
Fish

Venison
Mushrooms
Bell pepper
Jalapenos

Picante sauce
Cajun seasoning
Lemon pepper
Italian dressing

- Notes -

In Dutch Oven cooking it is important to have coals all around the Dutch Oven. In our Christian lives we are stronger when we surround ourselves with other Christians.

Dutch Oven Cooking

Dutch Oven Cooking is often used as a way to prepare food in an outdoor setting. The Dutch Oven can be used not only as a skillet, griddle, stewpot, saute pan, or warmer but also as the traditional oven. The Dutch Oven lid can also be turned over and used as a griddle, wok, or skillet. Please understand that these are sometimes referred to as Camp Ovens since they have three stubby legs on the bottom side which allow them to be used on an outdoor campfire. These legs raise the oven off of the coals so that it does not smother out the fire. It also should have a somewhat flat lid with a lip around the edge to hold coals. Do not confuse the Camp Oven with Dutch Ovens that have a flat bottom, rounded lid, and are designed for use in an indoor kitchen oven.



This manual will not try to cover all aspects of Dutch Oven cooking. There are basic Dutch Oven cooking books available which will be beneficial to the beginning Dutch Oven cook. This information will usually explain about “seasoning” Dutch Ovens as well as care. As far as the size is concerned, Dutch Ovens are commonly found from an eight inch diameter up to a sixteen inch or larger diameter. Most beginning cooks find that the twelve inch is the most easily secured and many recipes are sized to fit this oven.

Generally when baking, a good rule to remember is to have 1/3 of the heat on the bottom and 2/3 of the heat on top. If using charcoal briquettes on a 12” Dutch Oven you would use 9 underneath and 15 on top. *(The formula for determining the number of briquettes needed: size of the oven times two equals the total number of briquettes needed. For the bottom, use the size of the oven minus three briquettes. For the top use size of the oven plus three briquettes.)*

Cobblers

Now that we have covered some of the basics of Dutch Oven cooking, let’s prepare a cobbler. One of the first dishes that many people prepare is a simple fruit cobbler. They are relatively easy to prepare, nearly foolproof to cook, and always delicious to eat!

Getting Started

It is suggested that you try this in a twelve inch Dutch Oven, but if you have a different size available, use what you have. This recipe should provide enough for at least ten to twelve people to have a good sample. If more people are present, you might consider preparing a second dish or provide smaller samples.

The cook on a chuckwagon might not have used aluminum foil to line his oven, but it will make your cleanup much easier. Use about eighteen inches of wide, heavy duty aluminum foil to line the bottom and sides of your Dutch Oven before you start to prepare your cobbler. It is suggested to go ahead and cover the lid as well. Make sure the foil fits all the way into the bottom corners and does not have any tears that might leak. Be sure to flatten the foil along the sealing portions of the lid and that the lid fits down firmly onto the bottom part of the oven.

RECIPE

Ingredients for Cobbler

Make sure that you have these on hand before you start.

- 2 cans (29 oz. each) of sliced peaches or other fruit
- 1 yellow cake mix
- 1 stick of butter or margarine
- 1 cup of light brown sugar
- 1 teaspoon total of spice (cinnamon, ground clove, pumpkin pie spice or whatever you like)

Preparing the Cobbler

We are now ready to put it together! Although it is better to preheat your Dutch Oven, doing so can create something of a hazard for people trying to work around a hot pot! A good recommendation is not to worry about preheating the bottom, but you could preheat the lid since you would not be handling it. Start with your foil-lined oven and cube about one-third of the butter and scatter it around the bottom. Empty one of the cans of peaches, along with the juice, into the oven. Sprinkle a little of the spice and about one third cup of the brown sugar on top of the peaches.



Next sprinkle about one half of the dry cake mix over this mixture. Dot with another one third stick of butter, some spice, and another one third cup of brown sugar. Now pour the other can of peaches and juice over the cake mix. Top the peaches with the rest of the dry cake mix, butter, spice, and brown sugar.

- Notes -

One key to becoming a good Dutch Oven cook is to use your nose as well as your eyes to tell how something is cooking. In our Christian walk we should serve God with all that we have, not just one part.



Cooking the Cobbler

Place the lid on top of the oven making sure that it is seated well. Remember that the heat will damage the grass or ground. If possible, use something to keep the heat off of the ground. You can cook in a barbecue pit, metal tub with sand in it, a metal barrel lid supported on bricks, or whatever you can come up with. Place a shovel full of coals under the Dutch oven and another good shovel full of coals on top. Check the time when you start cooking. About every fifteen minutes lift the entire oven slightly and rotate it a quarter of a turn counterclockwise and

then lift the lid slightly and rotate it a quarter of a turn clockwise. This helps to eliminate hot spots. If it appears that it is not cooking hot enough, add a few more coals. If it appears to be too hot, remove a few coals or set it off of the bottom coals.

After thirty minutes, check for doneness. If it needs a little more cooking, let it continue, but check about every ten minutes or so. When it looks brown and appears to be done, remove the lid, dump off any remaining coals, and brush off any ash (a whisk broom works well for this). Be careful to brush downwind or you might wind up with a pot full of ashes! Most times, the cobbler will be better if it can sit for just a few minutes before eating. Please be aware that this cobbler will be **very hot** and can easily burn your mouth. A dip of vanilla ice cream is a tasty addition.



Pineapple Upside Down Cake

Here is another Dutch oven recipe that you can try. The following ingredients are needed for this recipe:

RECIPE

- 1 Twelve (or fourteen) inch Dutch Oven lined with a single piece of heavyweight aluminum foil.
- 1 Large (about 16-20 oz.) can of pineapple. This can be sliced, crushed or even chunks.
- 1/2 Cup light brown sugar
- 1 Stick margarine
- 1 Yellow cake mix
- 3 Eggs (per cake mix recipe)
- 1 1/3 Cups water (per cake mix recipe)
- 1/3 Cup vegetable oil (per cake mix recipe)
(may substitute 1 stick margarine)
- 1/2 Cup chopped pecans (optional)
- 1/4 Cup maraschino cherries (optional)

Preparing the Cake

To prepare a pineapple upside-down cake, line your Dutch Oven with a single piece of heavyweight aluminum foil just as we did for the cobbler. Unlike the cobbler, the lid will be lined with foil, after cooking, in order to flip this cake over and serve it with the pineapple on top. We will talk more about this later.

Start by cutting the stick of margarine into several small pieces and scattering them around in the bottom of the oven. (It is good to melt the margarine in the bottom of the oven, however, working around a hot pot creates problems.) Place the pecans in the oven if you are using them. Sprinkle the brown sugar on top of the nuts and margarine. Next drain the pineapple and place the fruit in the bottom of the Dutch Oven. If using pineapple slices, place a cherry in the center of each slice.

In a large mixing bowl, combine the cake mix with the eggs, water and oil according to the directions on the cake mix box. Mix thoroughly and stir vigorously for two minutes then gently pour the batter over the fruit, nuts, brown sugar and margarine. Try to spread it as evenly as possible without disturbing the bottom layer.



Our spiritual food includes the Bible, our Christian fellowship, witnessing, Bible study, worship, etc. All the blessings we receive from these help us grow spiritually.

- Notes -

“For His divine power has given us everything required for life and godliness, through the knowledge of Him who called us by His own glory and goodness. By these He has given us very great and precious promises, so that through them you may share in the divine nature, escaping the corruption that is in the world because of evil desires. For this very reason, make every effort to supplement your faith with goodness, goodness with knowledge, knowledge with self-control, self-control with endurance, endurance with godliness, godliness with brotherly affection, and brotherly affection with love. For if these qualities are yours and are increasing, they will keep you from being useless or unfruitful in the knowledge of our Lord Jesus Christ.”
(2 Peter 1:3-8)

Cooking involves taking the right ingredients, mixing them together, and applying heat to produce a finished product. We become more Christ-like when we allow Christ to work in our lives.

Cooking the Cake

After putting the lid in place and making sure that it is fitted snugly onto the bottom, place a shovel full of coals under the oven and place shovels full on top of the oven. After fifteen minutes, lift the lid slightly and rotate it one quarter turn clockwise. After seating the lid back onto the oven, lift the entire oven slightly and rotate it one quarter turn counterclockwise. Continue to check and rotate about every ten minutes. If more heat is needed add a few more coals. If it is too hot, remove some coals. When the cake springs back when touched, or a toothpick comes out clean, it is done. Remove from the heat and dump the coals and ash off of the lid (use a whisk broom).



Turning Out the Cake

Allow the lid to cool slightly and then cover the underneath side of the lid with heavyweight foil. A cardboard disc the same size as the oven can be placed between the foil and the lid to serve as a cake plate. After the cake has cooled for about fifteen minutes, replace the lid and carefully (but quickly), turn the Dutch Oven upside down to allow the cake to fall onto the lid. After removing the oven and carefully removing the foil that lined the bottom, your cake is ready to behold! If you used the cardboard disc under the foil, you can now remove the cake from the Dutch Oven lid and continue your cleanup. Although it rarely happens, the longer this cake sets, the better it gets! Please give this cake a try. It is not difficult to make and will surely be as impressive as it is delicious!



Trail Snacks

Trail snacks are a quick source of energy when you have little time to prepare meals. There are many types of trail snacks that can be purchased at the supermarket. Listed below is a simple recipe for a trail snack.

GORP (Good Old Raisins and Peanuts)

Combine two cups of M & M[®] candies, two cups (salted or dry roasted) nuts, and two cups of raisins. Other ingredients may be added, if desired. This makes a nutritious trail snack.



Cooking Devices

- 1 Cook pancakes, bacon, toast, or eggs on a tin can stove. Use a buddy burner as the fuel. (See Firecraft section.)
- 2 Use hooks to hang utensils close to fire.
- 3 Toast bread or roast wieners or marshmallows over coals with a forked stick.
- 4 Several utensils may be suspended from one pole. Sticks and pole must be green. Sticks should be sturdy enough to stand pounding and the pole strong enough to hold several pots. With an axe, sharpen the ends of sticks so they can be easily driven into ground. To prevent splitting of the forked sticks, do not pound them. Instead, lay a stick in the fork and pound it.

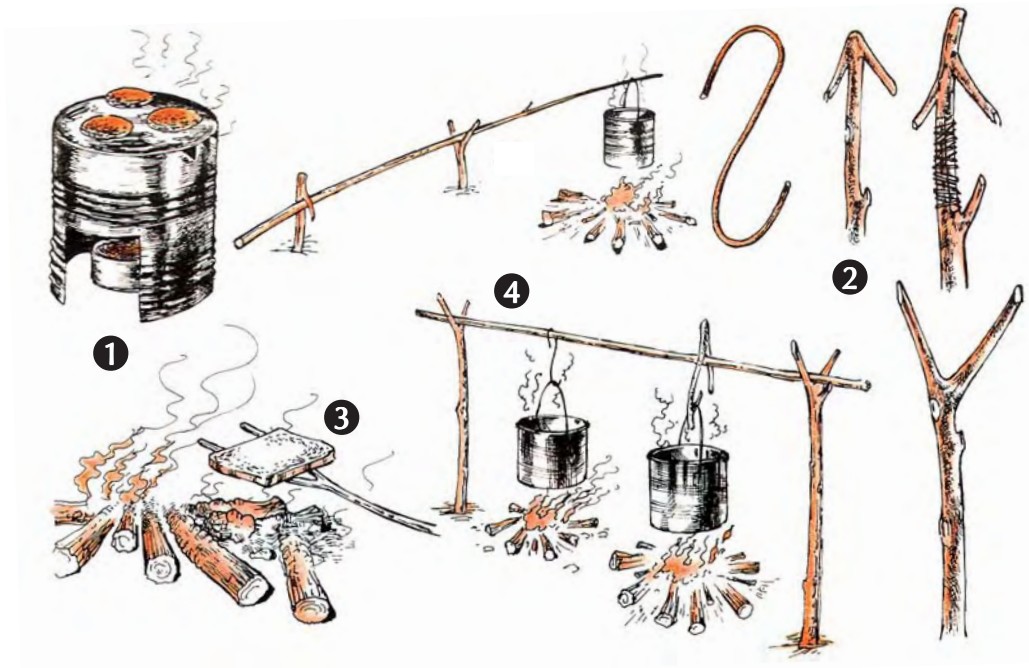

- Notes -

“Now, salt is good, but if salt should lose its taste, how will it be made salty? It isn’t fit for the soil or for the manure pile; they throw it out. Anyone who has ears to hear should listen!” (Luke 14:34-35)

Salt is made to season your food and to bring out the flavor. If it doesn’t, it is useless. We are the salt of the Earth to season the hearts of people and share with them the flavor of life who is Jesus. If we don’t, what kind of Christian are we? Useful or useless?

Cooking Tips

- Sugar substitutes are not good for quick energy in camp. Take along extra candies, cakes, or cookies for sugar replacement.
- Look for lightweight foods at your supermarkets. Much weight, expense and camp cooking may be avoided by wisely choosing some nourishing simple meals. Many of these are dehydrated or freeze-dried and need only water added to make tasty camp meals.
- Powdered whole or skim milk and dehydrated soup are easily prepared. Dried fruit may be eaten cooked or raw, and jams and jellies will add to your sugar supply.
- There are many types of MRE’s “Meals Ready to Eat” that can be purchased. The advantage of these is that little preparation and clean up time is required. The disadvantage is the cost and taste of the meals.
- Use plastic bags for transporting food. They are lighter than cans. Food wrapped in foil will stay fresh and may be easily handled.
- Shells of walnuts and hickory nuts added to your fire will improve the flavor of broiled steaks and fish. Be sure to remove the oily nut meats and use only enough shells to add to the smoke flavor.
- The outdoors has a variety of foodstuff for the camper who knows how to look for wild berries and who knows different ways to prepare wildlife species for the table. Consult a knowledgeable source before consuming any wild plants.
- Leather work gloves, pot holders, Channel-lock® pliers and lid lifters will help prevent burns. Hot pots and pans may be more safely handled with these tools.
- Allow adequate ventilation when using any stove. Don’t cook inside a tent.



Three Day Meal Planner

First Day
Breakfast

Second Day
Breakfast

Third Day
Breakfast

Protein Food

Cereal and/or
bread

Fruit or juice

Beverage

Utensils

Lunch

Lunch

Lunch

Main dish

Vegetable and/or
fruit

Salad

Bread

Dessert

Beverage

Utensils

Dinner

Dinner

Dinner

Main dish

Vegetable

Salad

Bread

Dessert

Beverage

Utensils

Number of Campers

Lads _____

Crusaders _____

Challengers _____

Adults _____

TOTAL _____

How many days? _____

How many meals? _____

Breakfast? _____

Lunch? _____

Dinner? _____

Snacks? _____

Checklist For Cooking

Beverage

- _____dairy drink
- _____cocoa
- _____fruit juice
- _____
- _____
- _____tomato juice
- _____
- _____

Bread and Cereal

- _____bread
- _____cold cereal
- _____
- _____
- _____cooked cereal
- _____
- _____

Canned Foods

- _____fruits
- _____
- _____
- _____meats
- _____
- _____
- _____soup
- _____
- _____
- _____vegetables
- _____
- _____

Dehydrated &

Dried Foods

- _____eggs
- _____fruit
- _____meat
- _____onions
- _____potatoes
- _____soup
- _____vegetables
- _____

Produce

- _____apples
- _____bananas
- _____celery
- _____carrots
- _____cucumbers
- _____grapefruit
- _____green peppers
- _____lemons
- _____lettuce
- _____melons
- _____onions
- _____oranges
- _____potatoes
- _____tomatoes
- _____
- _____
- _____
- _____

Cleaning Products

- _____soap for dishes
- _____soap for hands
- _____soap pads
- _____cleansers
- _____

Condiments/Dressings

- _____catsup
- _____honey
- _____jam
- _____jelly
- _____mustard
- _____olives
- _____peanut butter
- _____pickles
- _____salad dressing
- _____vinegar
- _____
- _____
- _____
- _____
- _____

Dairy Products

- _____butter
- _____buttermilk
- _____cheese
- _____cottage cheese
- _____eggs
- _____margarine
- _____milk
- _____sour cream
- _____

Meat

- _____bacon
- _____beef
- _____chicken
- _____ground beef
- _____ham
- _____sausage
- _____steaks
- _____wieners
- _____
- _____
- _____

Paper Products

- _____aluminum foil
- _____toilet paper
- _____garbage bags
- _____facial tissue
- _____paper cups
- _____paper plates
- _____paper sacks
- _____paper towels
- _____plastic bags
- _____plastic wrap
- _____wax paper
- _____cutlery
- _____

Miscellaneous

- _____
- _____
- _____
- _____

In following Jesus' example, many times we must meet the physical and medical needs of people before we can share the message of Jesus Christ with them.

*"I am sure of this, that He who started a good work in you will carry it on to completion until the day of Christ Jesus."
(Philippians 1:6)*

Emergency Action Steps

When responding to emergency situations, always follow the three emergency action steps. Using these steps can help to minimize confusion and lessen the chance of others becoming injured.

Check the scene to make sure that it is safe to approach.

- Is it safe to approach?
- What happened?
- How many persons are involved?
- Is there an immediate danger?
- Can others help respond?

If it is safe to approach, **check** each person that is ill or injured. Be sure to obtain consent from the individual before providing care. If you suspect something is wrong, ask questions that will help you determine if they are ill or injured. Some times people deny anything is seriously wrong with them and avoid medical attention.

Call 9-1-1 or the local emergency number. This call will activate the emergency medical system. Every minute is important in serious medical emergencies.

Care for the ill or injured person. When providing care for the person, strive to "Do No Further Harm" to the individual. Pray for God's intervention.

First Aid Kits

A first aid kit is a necessity for each group. Having the proper first aid items is as important as knowing how to treat injuries. While many commercially produced first-aid kits are readily available, assembling a kit from scratch is an excellent training exercise. There is not an exact list of components for a first-aid kit. Your groups's activities might dictate a list different from another group's activities. For example, a kit prepared for a campout in a remote national park might contain more items than a kit for an afternoon hike.

Group First Aid Kit

Leaders should carefully watch the shelf life of the components of your first-aid kit. Items are stamped with the date they expire. Many items will have to be replaced yearly. Be sure to check and restock the first-aid kit as a part of trip planning.



A variety of containers from metal boxes to cloth bags can be used to hold first aid supplies. The container should be sturdy and well marked. Each person in the group should know where the kit is located.

The following items can be used in a group first aid kit:

- A roll or two of one-inch or wider gauze bandage.
- Two to four-inch gauze pads for larger wounds.
- One or two inch adhesive tape.
- Adhesive bandages (such as Band-aids®).
- A triangular bandage or bandana.
- Elastic-roller bandage (Ace wrap®).
- Waterproof matches, needle, scissors, safety pins, and tweezers.
- Cotton balls and Q-tips®.
- Antiseptic soap or antiseptic towelettes.
- Antiseptic solution or cream.
- Pain relievers such as aspirin, ibuprofen, or acetaminophen.
- Benadryl® or other antihistamine.
- Hydrocortisone cream and calamine lotion.
- Triple antibiotic cream.
- Upset stomach medication.
- Anti-diarrheal medication.
- Moleskin.
- Bite sticks for insect bites and stings.
- Latex gloves.
- Duct tape.
- Accident report form, small notebook and pencil.

Important: Before giving or applying any first aid medication, check with the injured person for any allergies.

Additional items for a wilderness outing:

- CPR life mask shield.
- Hot packs and cold packs.
- Space blanket.
- Sam splint®.
- Ammonia inhalants.
- Hypothermia thermometer.
- Water purification-iodine, chlorine bleach, or halazone tablets.

Personal First-Aid Kit

Campers should carry a personal first-aid kit. Personal kits might include the following:

- Personal medications.
- Bandages.
- Adhesive tape.
- Roll of gauze bandage.
- Moleskin.
- Pain reliever (aspirin, ibuprofen, or acetaminophen)
- Antiseptic towelettes.
- Triple antibiotic cream.



“Jesus took up the question and said: ‘A man was going down from Jerusalem to Jericho and fell into the hands of robbers. They stripped him, beat him up, and fled, leaving him half dead. A priest happened to be going down that road. When he saw him, he passed by on the other side. In the same way, a Levite, when he arrived at the place and saw him, passed by on the other side. But a Samaritan on his journey came up to him, and when he saw the man, he had compassion. He went over to him and bandaged his wounds, pouring on oil and wine. Then he put him on his own animal, brought him to an inn, and took care of him. The next day he took out two denarii, gave them to the innkeeper, and said, “Take care of him. When I come back I’ll reimburse you for whatever extra you spend.” Which of these three do you think proved to be a neighbor to the man who fell into the hands of the robbers?’ ‘The one who showed mercy to him,’ he said. Then Jesus told him, ‘Go and do the same.’” (Luke 10:30-37)

- Notes -

*"They will look at the one they pierced."
(John 19:37)*

A wound heals, but the scar remains. Christ heals our wounds but the scars remain as a testimony.

A splinter causes pain and can become infected if not removed. Sin can be compared to a splinter in that it causes pain and infects our life if not treated. To remove sins from your life, confess them to Christ and ask for His healing.

First Aid Treatments

The information in this section is intended to be used as a general guide for commonly accepted first aid treatments. It is recommended that individuals receive training through a recognized first aid training center. **Leaders should be trained in first aid and CPR.** If you are planning a trip where you may be more than two to three hours from emergency medical care, the camp or trip leader should consider completing a Wilderness First Aid course. Your local chapter of the American Red Cross is a good source for these courses.

In preparation for any trip, you should find out about the emergency services available in the area in which you will be. Get the addresses and phone numbers for these services. Remember, some rural areas do not support 911 and cell phones requiring an evacuation in case of severe injury.

Cuts and Scratches

Wash a small wound with soap and water. Dry the skin and cover the wound with an adhesive bandage. Cover a large wound with a sterile compress, wrap with a triangular bandage or a clean bandana and seek medical help. Antiseptic may be applied to skin surrounding a wound but not in it.



Splinters

Use a pair of tweezers to pull a splinter from under the skin. Apply triple antibiotic ointment to the wound and cover with a bandage.

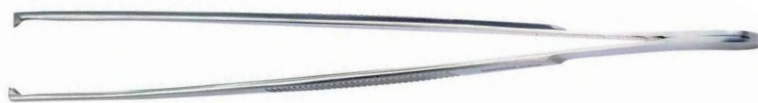

Blisters

Blisters develop over a period of time and often you can feel a sore place or irritation ("hot spot") starting. Early detection and treatment is the key to preventing full grown blisters. If you feel a "hot spot", do the following:

- Take off your boots and socks immediately and remove any sand or gravel from your feet.
- Let your feet dry and cool down.
- Cover the sore area with surgical tape, band-aid, or blister Moleskin that can be purchased in most drugstores. Try to avoid breaking the skin.
- Remove the moleskin once you stop hiking and let the skin recover during the night. The next morning, you can judge for yourself whether to apply a new cover or not. In general, take precautions and apply moleskin even if the area is only moderately irritated.

Burns

Burns can be caused by exposure from the sun, chemicals and fire or hot items. First eliminate the cause and then cool the burned area with clean or sterile cool running water if skin is intact. Loosely cover with a sterile bandage for protection. Seek medical help for serious burns.



Fainting, Shock or Heat Exhaustion

Identified by pale and cold moist skin, shallow rapid breathing and weak pulse. First Aid: Maintain body temperature, lay them on their back, with feet elevated and clothing loosened.



Face is pale, raise the tail.

Heatstroke

Identified by red and dry skin, strong pulse, headache, nausea, dizziness. First Aid: Get the person out of the sun and keep him cool. Lay them on their back, with head elevated. Reduce body temperature with sponge baths. Give them cool water when conscious. (Do not try to give an unconscious or semiconscious person anything to drink.)



Face is red, raise the head.

"They will not hunger or thirst, the scorching heat or sun will not strike them; for their compassionate One will guide them, and lead them to springs of water." (Isaiah 49:10)

- Notes -

“So we must not get tired of doing good, for we will reap at the proper time if we don’t give up. Therefore, as we have opportunity, we must work for the good of all, especially for those belonging to the household of faith.” (Galatians 6:9-10)

Breathing Emergencies

A breathing emergency is a life threatening condition that occurs when an individual is having trouble breathing naturally or can not breathe at all.

Causes of breathing emergencies include:

- A partially obstructed airway.
- Illness.
- Chronic conditions such as asthma.
- Electrocutation.
- Heart attack.
- Injury.
- Allergic reaction.
- Drugs.
- Poisoning.
- Emotional distress.



Choking (Conscious – Cannot Cough, Speak or Breathe)

If a person is choking and he **can** cough, speak and breathe, continue to encourage him to cough forcefully to dislodge the object. If he **cannot** cough, speak or breathe then provide the following care:

1. Have someone **Call 9-1-1**.
2. Obtain consent to help.
3. Lean the person forward and give **5** back blows on the back, between the shoulder blades, with the heel of your hand.
4. Give **5** quick, upward abdominal thrusts.

Each back blow and abdominal thrust should be a separate attempt to expel the object. Continue this sequence until the object is dislodged or the person becomes unconscious. (The person providing this care should have completed first aid training.)



Unconscious Person (Not Breathing)

The following procedures are used to provide care for an unconscious person who is not breathing:

1. **Check** the scene, then **check** the person.
2. Tap him on the shoulder and shout, "Are you okay?"
3. No response – **Call 9-1-1**
4. Open the airway (head tilt – chin lift) then look, listen and feel for breathing for 10 seconds.
5. If they are not breathing – give two rescue breaths.
 - For a child (ages 1-11) – look, listen and feel for breathing while checking for a pulse. A child with a pulse that is not breathing – give one rescue breath every 3 seconds. If no pulse then begin **CPR**.
 - For an adult (ages 12 and above) begin **CPR**.



An adult that is unconscious and shows no other signs of life (movement or breathing) may be in cardiac arrest. **CPR** (cardiopulmonary resuscitation) is a combination of chest compressions and rescue breaths that can help circulate blood containing oxygen to vital organs until emergency responders arrive. The person providing this care should have completed **CPR** training. Unlike adults, children seldom initially suffer a cardiac emergency. Instead they suffer a breathing emergency that results in a cardiac emergency.

- Notes -

"But He was pierced because of our transgressions, crushed because of our iniquities; punishment for our peace was on Him, and we are healed by His wounds." (Isaiah 53:5)

Severe Bleeding

Bright red blood coming in spurts is from the arteries. First aid for arterial bleeding:

1. Apply direct pressure on the wound and elevate the affected area. Hold pressure until the bleeding stops.
2. Apply pressure at pressure points; at temple, under jaw, collarbone cavity, under side of upper arm, and in pelvic cavity where thigh and abdomen join. Use the point nearest the wound on the side closest to the heart.
3. Tourniquet is **used only in extreme emergency** if limb is severed or bleeding cannot be stopped by techniques in number one or two. Once applied, it should not be loosened except on advice of a physician. Record the time the tourniquet is applied.

Nosebleeds

For nosebleed, place a cold compress over the nose. Place pressure on the bleeding nostril.



Bruises, Sprains and Strains

Sometimes it is difficult to know if a muscle, bone or joint injury is a fracture, dislocation, sprain or strain. Care given is the same for each of these injuries. General care includes following **R.I.C.E.**

Rest – do not move or straighten the injured area.

Immobilize – stabilize the injured area only if it does not cause more pain.

Cold – apply an ice pack or cold compress to the injured area. (20 minutes on – 20 minutes off) Place a thin barrier between the ice pack and bare skin.

Elevate – the injured area if it does not cause more pain.

Broken Bones

- Never try to “set” a broken bone.
- Have the person lie down and keep him as comfortable as possible.
- Apply cold compresses to ease pain.
- Treat for shock if necessary.
- Send for medical help immediately.
- If person must be moved to medical help, immobilize the broken bone by splinting with the best material available. Old papers and magazines with rags often make good splints. Don't place anything hard or heavy against the injured area.

Poison Ivy, Oak or Sumac

Refer to the Nature section to know how to identify poisonous plants. When you know you have touched any poison plant, do not scratch or you will simply spread the rash. Wash thoroughly with soap, preferably antibacterial, or with alcohol and apply a coating of calamine lotion or a similar poison ivy medicine. Take cool or lukewarm baths. Be aware that some people are highly sensitive to poisonous plants and may need medical attention.



"Is there no balm in Gilead? Is there no physician there? So why has the healing of my dear people not come about?" (Jeremiah 8:22)

God is concerned with not only our physical well-being but also our spiritual.

Snake Bites

Very few people die as a result of snake bites. Improper treatment can result in more injury to the person bitten than the snake bite itself. Strive to do no further harm to the injured person.

1. Keep the person calm and still.
2. Identify the snake if possible.
3. Call 9-1-1 or the nearest medical facility (transport if more than an hour from medical care).
4. Wash the wound.
5. Keep the injured area still and lower than the heart.
6. If bitten by a Coral snake, apply an elastic-roller bandage (Ace wrap®).



Do Not: apply ice, cut the wound, apply suction, apply a tourniquet or use electric shock.

Insect Bites

Bites of mosquitoes, ants, bees, hornets, wasps, chiggers, and other insects cause pain and itching because of an irritating acid injected into the flesh. Remove stinger (if present) with tweezers or by scraping with a credit card or similar stiff card. Apply sting stick to neutralize the acid. Some people are extremely allergic to insect stings or bites and will need quick medical help.



Photo not to scale.

Ticks and mites sometimes carry infectious diseases and should therefore be removed carefully as soon as you notice any on your body. Remove carefully with tweezers. Clean the bite area thoroughly with soap and water, then apply triple antibiotic cream.

Ice Packs

Ice packs are helpful in first aid. The cool ice pack reduces swelling in sprains, stings, bruises (including black eyes), and can even help get rid of hiccups. Follow the steps below to make an ice pack.

1. Wrap ice in a towel.
2. Crush ice with a hammer by hitting ice through the towel.
3. Put crushed ice in a plastic "zipper" bag.
4. Wrap bag with towel and apply to injury. For hiccups, put ice pack on stomach.



Hypothermia

Hypothermia, the severe cooling of the body, is a serious problem and can be critical. It can result in serious injury or death. Hypothermia results when the body temperature drops below 95 degrees. It happens as a result of body heat loss exceeding body heat gain and is a gradual process that happens over a period of time. It is not just a winter problem. Body heat loss can be caused by evaporation as we perspire, breathing out warm air and in cold air, touching something cold, uncovered parts of the body exposed to the cold, swimming in cool or cold water and cooling by wind.

Stages of Hypothermia

- **Stage 1 - Mild Hypothermia Symptoms** - The person feels cold and goose bumps form. Mild shivering occurs. Breathing may become quick and shallow and speech may be slurred. **Treatment** - Move the person to a warm place. Remove any wet clothing. Give warm drinks (not caffeine or alcohol) and keep the person warm for several hours.
- **Stage 2 - Moderate Hypothermia Symptoms** - Begins with violent, uncontrollable shivering and may progress to where shivering slows or stops. The person may suffer from memory loss, disorientation, incoherence, slurred speech, drowsiness, apparent exhaustion and some loss of muscle control. **Treatment** - Use all the treatment methods used for a mild case (except warm drinks). Cover person with warm clothing and blankets to stop further heat loss. Seek medical attention immediately.
- **Stage 3 - Severe Hypothermia Symptoms** - The person may collapse, become unconscious and show signs of respiratory distress. **Treatment** - Keep person prone, on his back and immobile. Cover with warm clothing and blankets to stop further heat loss. Arms and legs should not be stimulated in any way and the person should be handled with care. If the cold blood in the extremities suddenly returns to the core, it could cause cardiac arrest. Seek medical attention immediately.



Frostbite

Frostbite is damage to body tissue caused by being frozen. Frostbite causes a loss of feeling and a white or pale appearance in extremities, such as fingers, toes, ears or the tip of the nose. If symptoms are detected, get medical help immediately. If you must wait for help, slowly rewarm affected areas. However, if the person is also showing signs of hypothermia, warm the body core before the extremities because cold blood driven toward the heart can lead to heart failure.

*"For I am not ashamed of the gospel, because it is God's power for salvation to everyone who believes, first to the Jew, and also to the Greek."
(Romans 1:16)*

*"I was naked and you clothed me; I was sick and you took care of me; I was in prison and you visited me."
(Matthew 25:36)*

Poisoning

A poison is any substance that can cause injury, illness or death when introduced into the body. A person can be poisoned by ingestion, inhalation, injection or absorption through the skin. If you suspect that a person is showing signs of poisoning:

1. Get medical help immediately by contacting the nearest medical or poison center. **National Poison Control Center (800) 222-1222.**
2. Keep the victim calm and comfortable.
3. Use caution in seeking to determine what has poisoned the person.
4. Read the label on the container of poison and follow the antidote or counter dose suggested. There are times when you do not induce vomiting, such as with acids or lye.



Drowning

1. **Reach** first, if at all possible, using your leg, a pole, a stick, rope or anything to which the victim can grab hold.
2. **Throw** a life ring, rope, inner tube, log, ice chest, or anything that will float and the victim can grab.
3. **Row** any kind of boat that is handy.
4. **Go** is the last resort after each of the above has been tried or is impossible. You should go to the victim only if you are a good swimmer and a trained life saver. Carry a towel or shirt in your teeth and flip it to him when close enough, then pull him in. If you don't have the skill to help, go get help!
5. If a person is not breathing, use rescue breathing or CPR. Also treat for shock.



Stroke

A stroke is caused by blockage of blood flow to part of the brain. As with other sudden illnesses, the primary signals of a stroke are a sudden change in how the body is working or feeling. Think **F.A.S.T.** to recognize a stroke.

- **Face** – ask the person to smile. Note if there is weakness in the muscles on one side of the face.
- **Arms** – ask the person to raise both arms. Note if they are experiencing difficulty raising either limb.
- **Speech** – ask the person to repeat a simple sentence. Note if they are experiencing slurred speech or having trouble getting the words out.
- **Time** – Record the time when you noticed that these signals began and **call 9-1-1** to get help right away.

SAFETY & SANITATION



- ✓ Hiking Safety
- ✓ If You Get Lost
- ✓ Survival Skills
- ✓ Safe Drinking Water
- ✓ Tool Safety
- ✓ Fire Safety
- ✓ Weather Safety
- ✓ Personal Hygiene and Washing
- ✓ Dish Washing
- ✓ Safe Storage
- ✓ Garbage Disposal
- ✓ Human Waste Disposal
- ✓ Leave No Trace Principle

- Notes -

*"I will both lie down and sleep in peace, for You alone, LORD, make me live in safety."
(Psalm 4:8)*

Being able to walk and hike safely can help lead others out of danger. Being able to share the message of Jesus Christ can help lead others to the Lord.

Hiking Safety

- **Pack** - Travel as light as possible. Carrying too heavy of a load may cause strains, sprains, or discomforts which take the fun out of hiking.
- **Repellent** - In warm seasons, always have with you a good insect repellent.
- **Reaching and Stepping** - Watch out and be careful where you reach and step. Unseen dangers may be harmful insects or animals (spiders, snakes, etc.) or loose ground or rocks which might cause you to lose your footing.
- **Shoes** - Wear well-fitting, comfortable lace-up shoes or hiking boots. Break in new shoes or boots before going on a hike.
- **Gear** - Carry a first aid kit, foot powder, extra pair of socks, moleskin for blisters, waterproof matches, pocket knife, hat/cap, whistle. Have a compass and map with you if going cross-country. Carry rain gear if weather is uncertain.
- **In Woods**
 - Follow and stay on marked trails for safety and conservation reasons.
 - Hold aside a branch or limb blocking the trail for person coming behind you.
 - Be careful about picking and eating wild plants or berries. Learn which plants are edible.
- **On Roads**
 - Be aware of your state's laws regarding hiking and biking on roads.
 - Walk single file on the edge of the road or shoulder facing oncoming traffic.
- **With Others** - For safety and fellowship, always hike with a buddy or a group.
- **Travel Plans** - Let a parent, your leader, or some other adult know your travel plans - when, where, how long, when you plan to return, who's going, etc.



*"The fear of man is a snare, but the one who trusts in the LORD is protected."
(Proverbs 29:25)*



If You Get Lost

- **Carry** with you waterproof matches, pocket knife, whistle, drinking water.
- **Sit** down, stay calm, rest, try of figure out where you are.
- **Pray** for comfort, clear thinking, and a safe return.
- **Climb** a tree, hill, or other structure to check your surroundings and route traveled.
- **Trace** your trail back as far as you can, marking it with strips of cloth or twine or broken limbs, until you see whether you are on a recognizable path or where you might have gotten off.
- **Travel** down hill or down river - do not wander aimlessly.
- **Blow** your whistle 3 times quickly or shout every 20-30 minutes. Someone may be able to hear and locate you.
- **Build** a fire if you think others will be looking for you - a smoky fire in daytime and a bright fire at night.
- **Make** a shelter if night comes or weather turns threatening - rest or sleep as best as you can.



Stop
Think
Observe
Pray & Plan

"For by grace you are saved through faith, and this is not from yourselves; it is God's gift – not from works, so that no one can boast. For we are His creation – created in Christ Jesus for good works, which God prepared ahead of time so that we should walk in them." (Ephesians 2:8-10)

Survival Skills

Each year people who enjoy outdoor pursuits find themselves in unexpected emergency conditions. Often, this is the result of the person becoming disoriented (lost), injured, stranded or due to unexpected changes in the weather. The keys to survival are to remain calm, maintain a positive attitude and use your mind to help you make adjustments.

Thanks to modern communications such as cell phones and two-way radios, most of the people who are faced with an emergency condition spend several hours rather than several days in the outdoors. With today's methods of search and rescue the majority of the missing people are located within 72 hours after they have been reported missing. However, for some who do not take proper precautions or use survival skills the experience can have tragic consequences.

Think through recent events. Determine your options. If you decide that you can not return to a safe place, commit yourself to spend the night where you are. If you remain in one spot, it is very likely that the rescuers will locate you in a few days. For every hour that you travel aimlessly, it quadruples the size of the search area. Once you have committed yourself to remaining where you are, you have three priorities:

- **Shelter** - find or construct a shelter.
- **Fire** - gather wood and build a fire for warmth.
- **Signal** - the international emergency sign for distress is three of any signal; three whistle blast, three flashes with a mirror or three fires evenly spaced. If you are near an open space make an "X" as large as possible. Placing logs or rocks along the "X" will make it more visible from the aircraft. Do not light signal fires until you hear an aircraft. Adding green limbs with leaves to the fire will help create smoke.

Survival Kits

Assembling a survival kit will help you to be prepared to spend several unexpected days in the wilderness. The survival kit is important not only for its lifesaving merits but also to help provide comfort. Consider items that you carry in your pack that can be used to help you to be prepared to survive.

Suggested Items for a Personal Survival Kit:

- Tube Tent - lightweight plastic emergency shelter that can be constructed quickly.
- Space Blanket (Bag) - lightweight Mylar fabric that reflects 90% of radiated heat.
- Fire Starters - have several dependable ways to start a fire.
- Signaling Devices - flash light, police whistle, signal mirror.
- Water Purification - have a dependable method for purifying water and a backup plan.
- Rope or Cord - 50' of rope or parachute cord.
- Aluminum Foil - 2 - 18" x 36" pieces of heavy duty foil.

The Priorities of Survival are known as the **Rules of Three**:

- **Three Seconds** - You may be doomed in three seconds if you let panic rule.
- **Three Minutes** - You can not live more than three minutes without oxygen.
- **Three Hours** - You can not live more than three hours in temperature extremes without shelter.
- **Three Days** - You can not live more than three days without water.
- **Three Weeks** - You will need food in three weeks.

Safe Drinking Water

Carry from home one or more full water bottles or canteens. If needed, refill bottles or canteens from a tested, safe public water system. Be careful to drink an adequate amount of water to prevent dehydration. It may be necessary on longer hikes or campouts to make water from natural sources safe for drinking and cooking by purification.

Water Purification

One of the following methods may be used to make water safe and pure:

- **Boiling** - Strain water through cloth before boiling. Heat the water until it comes to a rolling boil (large bubbles rising from the bottom of the pot). Let water boil for five minutes. Allow water to cool. Pour water from one clean container to another several times to add air to lose the "flat" taste boiling produces.
- **Chemical** - Use water purification chemical tablets as directed on package. These tablets may be purchased at various stores.
- **Bleach** - Use 4 drops of chlorine bleach per gallon of water. Shake well. Wait 30 minutes before drinking.
- **Water Filter** - Use a .5 micron filter to remove harmful bacteria from water. Water purification filters can be purchased at various outdoors stores.

Tool Safety

- Tools are not toys. Learn how to use each tool correctly and safely.
- Whittle or cut away from your body.
- Keep knives, axes, and saws sharp.
- Use a chopping block with axes and a sawbuck with saws.
- Never lay a tool on the ground. Build a tool rack for a place to keep tools safe.
- Keep sheaths on sharp tools when not in use.
- Before using an axe, clear an area in all directions of at least two axe handle lengths of all people, brush, branches, and other obstacles.
- Wear safety goggles because there may be the chance of flying wood chips.

Fire Safety

- Clear enough ground for the size fire you plan to build. Be sure there are no overhanging limbs.
- Build fire only big enough for the intended purpose.
- Keep water, sand, and/or a large, wet towel handy to help put out a fire quickly.
- Never leave a fire unattended.

*"Then Moses led Israel on from the Red Sea, and they went out to the Wilderness of Shur. They journeyed for three days in the wilderness without finding water. They came to Marah, but they could not drink the water at Marah because it was bitter—that is why it was named Marah. The people grumbled to Moses, 'What are we going to drink?' So he cried out to the LORD, and the LORD showed him a tree. When he threw it into the water, the water became drinkable. He made a statute and ordinance for them at Marah and He tested them there."
(Exodus 15:22-25a)*

Weather Safety

Weather conditions can be the most uncertain factor in preparing for an outdoor adventure. While the science of meteorology continues to advance, many people continue to joke about the accuracy of weather forecasts. Yet prudent leaders should check these forecasts prior to leaving. If there are chances for some extreme weather, delaying or modifying a trip might be appropriate. The disappointment over a postponed trip will pale in comparison to the lasting memories of injuries or fears from a trip turned bad. Becoming aware of potential weather conditions and learning safe techniques to respond with will greatly enhance your outdoor skills.

Cold Weather Conditions

Cold weather offers many different conditions that can require serious responses. A winter storm, for example, can last for several days and be accompanied by high winds, freezing rain or sleet, heavy snowfall and cold temperatures. Campsites must be prepared for the possibility of high winds, ice can make trails extremely hazardous and heavy snow can cover trails and block visibility making it easy to get lost. Winds and dropping temperatures will increase the chances for hypothermia. The accompanying Wind Chill chart shows the ranges to watch.

Estimated Wind Speed in MPH	Actual Thermometer Reading (F)											
	50	40	30	20	10	0	-10	-20	-30	-40	-50	-60
	Equivalent Temperature (F)											
Calm	50	40	30	20	10	0	-10	-20	-30	-40	-50	-60
5	48	37	27	16	6	-5	-15	-26	-36	-47	-57	-68
10	40	28	16	4	-9	-21	-33	-46	-58	-70	-83	-95
15	36	22	9	-5	-18	-36	-45	-58	-72	-85	-99	-112
20	32	18	4	-10	-25	-39	-53	-67	-82	-96	-110	-124
25	30	16	0	-15	-29	-44	-59	-74	-88	-104	-118	-133
30	28	13	-2	-18	-33	-48	-63	-79	-94	-109	-125	-140
35	27	11	-4	-20	-35	-49	-67	-82	-98	-113	-129	-145
40	26	10	-6	-21	-37	-53	-69	-85	-100	-116	-132	-148
Wind Speeds Greater than 40 MPH have little additional effect	Hypothermia Risk <i>(for properly clothed person)</i>				Frostbite Danger <i>(for properly clothed person)</i>				Severe Risk			

A person can suffer from hypothermia as easily as getting wet in a rain shower, then standing or sitting in a draft. Some tips to avoid hypothermia:

- Wear proper clothing. Use wool for insulating effect. Use nylon for wind protection. Keep clothing dry and ventilated. Remember that several layers of light clothing provide more insulation than one heavy garment.
- Avoid exposure of skin in the winter. Wear a cap on your head. The body gives up more heat through the head than from any other area.
- If you get wet, dry off as soon as possible and put on dry clothing.
- Seek shelter during bad weather.
- Eat high energy food and drink liquids as you hike.
- Hike at a reasonable pace, slow but steady.

Fog

Fog can affect outdoor activities in two different ways. It can greatly restrict visibility and prevent hikers from seeing reference points indicated on maps.

- Fog makes it very easy to get disoriented and become lost. If fog sets in, delay traveling until visibility is restored.
- The moisture from fog can increase the chances of hypothermia. Wear rain gear if necessary to stay dry.

Hot Conditions

In hot weather, heat exhaustion and heat stroke become a major concern. Outdoor activities can increase the effects of heat on people. Humidity will affect the bodies ability to cool itself by perspiration. The heat index chart shows the temperature a body feels. The following steps should be taken to reduce the chances of heat exhaustion or heat stroke:

- Wear appropriate clothes. Long sleeved, lightweight, light colored clothing reflects heat and sunlight to help your body stay cool. Wide brimmed hats help block sunlight.
- Slow down. Strenuous activities should be reduced or rescheduled to the coolest time of the day.
- Drink plenty of water or other non-alcoholic drinks to replenish fluids lost by perspiration. Avoid alcohol or caffeinated drinks because of their diuretic properties that increase the flow of urine and increase the chances of dehydration.

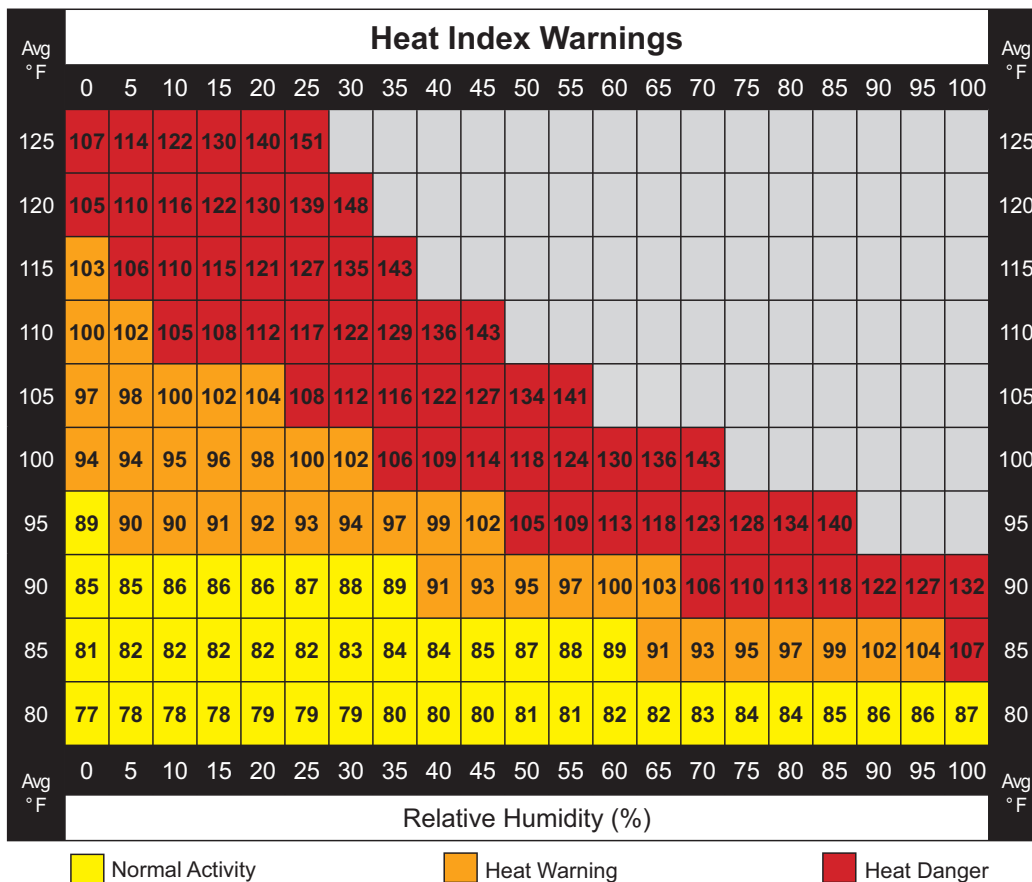

- Notes -

God has given us instructions in all areas of life - how to get along in nature and how to properly care for ourselves. Not only is God concerned with our safety, He is equally concerned with our spiritual safety. The Bible is full of instructions on how we might keep ourselves healthy and safe in mind and body.

Severe Weather

In many parts of the country, severe weather can appear with very little warning. Keeping a watchful eye on the weather and reacting quickly can help you avoid dangers.

High Winds often occur with severe weather. When hiking, attempt to find shelter. If in camp, secure any gear outside of tents. Check all tent tie-downs and stakes.

Hail many times will accompany thunderstorms. Seek shelter quickly. If caught out in the open, use backpacks or other gear for protection.

Tornadoes, while fairly uncommon, may present a high risk of injury. Seek substantial shelter immediately. If there is no shelter nearby, lie flat in the nearest ditch, ravine or culvert with your hands shielding your head.



Lightning often may be the first indication of approaching severe weather. Lightning strikes more than 400 persons each year in the United States. On average, about 70 people are killed and many others suffer permanent neurological disabilities. Most of these tragedies can be avoided if proper precautions are taken. Outlined below are facts and suggestions you should follow in

developing a personal safety plan to lessen your chances of being struck by lightning.

When you first see lightning or hear thunder you need to activate your personal safety plans. Remember this saying:

If you see it, flee it!

If you hear it, fear it!

- Lightning often precedes the rain.
- Lightning can strike objects more than 10 miles from the cloud.
- Lightning can strike twice in the same place.
- You can determine how far away the lightning is by counting the seconds between the lightning flash and sound of thunder. Every five seconds equals one mile.

If you are outdoors you should:

- Avoid being near water (ponds, lakes, streams, gullies)
- Avoid the high ground (hills, ridges, peaks)
- Avoid all metal objects (electric wires, fences, machinery, etc.)
- Avoid unsafe places (underneath canopies, small picnic or rain shelters, or near tall trees)
- Seek shelter if possible (substantial buildings or a vehicle with a metal roof and the windows closed)

If you are outdoors and lightning is striking near by you should:

- Crouch down on the balls of your feet, place your hands over your ears, and bend your head down. Make yourself as small a target as possible and minimize your contact with the ground. Do not lie flat on the ground.
- Avoid being close to others (minimum of 15 feet apart).



If you are indoors you should:

- Avoid water
- Stay away from the windows and doors
- Do not use the telephone or electrical appliances or devices. Lightning may strike exterior electric or phone lines, inducing a shock to inside equipment.

Suspend activities for at least 30 minutes after the last observed lightning or thunder.

Injured persons do not carry an electrical charge and can be handled safely for first aid procedures. Call 911 or send for help immediately if someone has been struck by lightning.



*"Who can understand His mighty thunder?"
(Job 26:14)*

Hand washing can remove not only dirt but germs that can cause infection. It doesn't take much sin to "infect" our lives, but Christ can clean and heal our lives.

Personal Hygiene and Washing

Personal Hygiene

Good personal hygiene and care is necessary in the outdoors as well as at home. The following suggestions should be followed:

- Socks and underwear should be changed daily when possible.
- Daily bathing should be done when possible. Brush teeth at least daily.
- Hands should be washed upon arising, before preparing and eating meals, after using the restroom or latrine, and before going to bed. Use biodegradable soap.
- Feet should receive attention and be well cared for. Keep dry. Use foot powder. Avoid blisters by wearing well-fitting shoes/boots. If blisters develop, avoid breaking the skin and cover with moleskin or thick bandage.
- Rest periods should be scheduled to prevent overexertion or excessive fatigue. Sufficient rest and sleep are important.
- A complete body check should be made at the end of each day for ticks, rashes, etc.
- Have a complete medical checkup at least once a year.

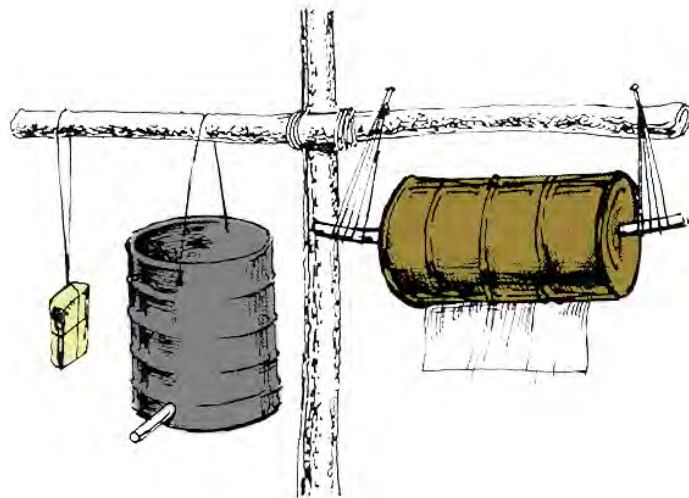

Personal Washing

- **Hands** - Use biodegradable soap or a waterless hand cleanser (may be purchased at various retail stores).
- **Hand Washing Stand** - For an overnight campout a hand washing stand may be built. Use tin cans or plastic bottles to hold water and paper towels. To catch runoff water, place a container under the water bottle or dig a hole and line it with small rocks.
- **Bathing** - Use public shower facilities if available. Otherwise, make your own camp bath/shower area. Secure a secluded area some distance from the campsite and any natural water source. Have 2 pots of water and biodegradable soap; 1 pot of water for soaping and washing and the other pot for rinsing. If desired, water may be heated by setting it out in sun or heating it on camp stove or fire. After use, broadcast leftover water over a wide area.

Dish Washing

- Notes -

- **Hikes** - Short day hike meals should be planned where no cooking or utensils are needed.
- **Camps** - Dish and utensil clean-up and washing steps:
 - Scrape out excess food into garbage container or bag.
 - Wash in pot or tub of hot water with biodegradable soap. Use scrub pads as needed. *Hint! Washing can be easier if you rub soap on the outside of the bottom and sides of pots, pans, and skillets before placing on fire.*
 - Rinse in clean water to remove soap.



- Sanitize rinse by immersing in scalding hot water for a minimum of two minutes or in lukewarm water with a commercial sanitizing chemical or a capful (1 tablespoon) of chlorine bleach per one gallon of water. *Hint! The last rinse can be done easily by placing dishes in a mesh bag and dipped into the hot water. Silverware may be also placed in a smaller mesh bag or in a can or plastic bottle with holes punched in bottom.*
- Turn dishes upside down on a clean towel or piece of plastic or hang up in a mesh bag to air dry.
- Strain food particles from wash water and place in garbage container.
- Broadcast wash and rinse water over a wide area some distance from campsite or water source.
- It is important to get food and grease off dishes and utensils to prevent food poisoning and illness.

- Notes -

We should keep our house in order so that if God chose to come through the door He would find no uncleanness among us. Build your life and strive to learn and follow the teachings of Jesus.

Safe Storage

Packs - Attach ropes to packs and suspend between two trees or suspend pack by throwing an attached rope over a tree limb and tying rope to the tree. This keeps packs out of dirt or mud and away from animals.

Food - In a base camp, place a portable chest on a lashed table and store food in chest and cover with a heavy canvas. Keep food and staples in closed containers to protect from ants or other insects. Since bacteria grows in the temperature range of 40°F and 140°F, food must be stored below 40°F and cooked and served above 140°F.

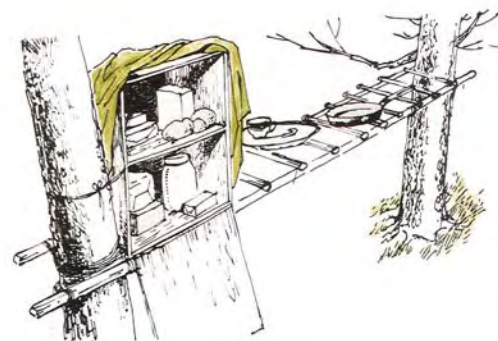

Garbage Disposal

On Day Hikes - Place all garbage and trash in plastic bags. Carry bags to a designated disposal area. (Pack In - Pack Out.)

On Camp Outs - Three methods of getting rid of garbage and trash are as follows:



1. Collect trash and garbage in bags hung from a tree branch high enough to keep out of reach of small animals.
2. Burn and Bury - If permissible, burn all garbage and trash. Place food and wet garbage on a screen or grill over fire to burn. Burn food out of cans. Flatten all cans and plastic bottles. Then bury all unburned trash and cover hole to ground level.
3. Pack In - Pack Out - If burning and burying is neither permitted nor desirable, place all garbage and trash in heavy plastic bags, seal or tie closed and carry away to a designated disposal area.

Human Waste Disposal

Coming upon a pile of human waste and soiled toilet paper is not healthy, slightly, or pleasant. Various ways of disposing of this waste are as follows:

- **Urine** - If toilet facilities are available close by, use them. If not, urinate at a spot away from camp, trails, natural water source, or where people might gather.
- **Solid Waste**
 - Toilet facilities - if available and close by, use them.
 - Cat-hole - For 1 person, 1 time use. Choose a secluded site some distance away from camp, trail, or water source. Dig a small hole 6-8 inches deep with a trowel or small shovel. Squat to use. Cover hole completely with soil you removed.
 - Latrine (outdoor toilet) - For a group on an overnight or longer camp. Choose a secluded, safe area some distance away (150 feet) from camp or natural water source. Dig a trench a foot or so wide and about 2 feet deep. Place removed soil, a shovel, and toilet paper nearby. Straddle trench to use. Cover your waste and toilet paper with dirt. Wash hands after use. For a camp lasting several days, build a more comfortable latrine by digging a trench between 2 trees, lashing a sturdy limb between the trees for a seat over the trench. Lash another limb higher up for a back rest. A tarp or brush around the latrine may be useful for privacy. Place toilet paper in a can or plastic bottle to protect from rain. Cut a slit for easy paper removal. *Hint! Devise a way to place an "occupied" sign along the trail going to the latrine.*



- **Pack It Out** - In certain areas and environments, latrines or cat-holes might be prohibited or waste might not easily decompose. In these cases, human waste needs to be carried out to designated disposal containers. Commercial sanitary waste disposal kits are available. Check with manager or ranger of camping area you are using concerning disposal of garbage and waste.

- Notes -

"You must have a place outside the camp and go there to relieve yourself. You must have a digging tool in your equipment; when you relieve yourself, dig a hole with it and cover up your excrement." (Deuteronomy 23:12-13)

"Leave No Trace" Principle

Replace all sod at fire sites. Fill in all holes and pack to level of ground. Pick up and remove all trash and litter. Take down any camp lashings or gadgets you have constructed. Do not disturb or harm natural plants and wildlife. Remember! For conservation and safety, good campers leave a site in the same condition they found it - or even better!

Leave only footprints. Take only memories.



"You will be confident, because there is hope. You will look carefully about and lie down in safety." (Job 11:18)

MAP & COMPASS

9

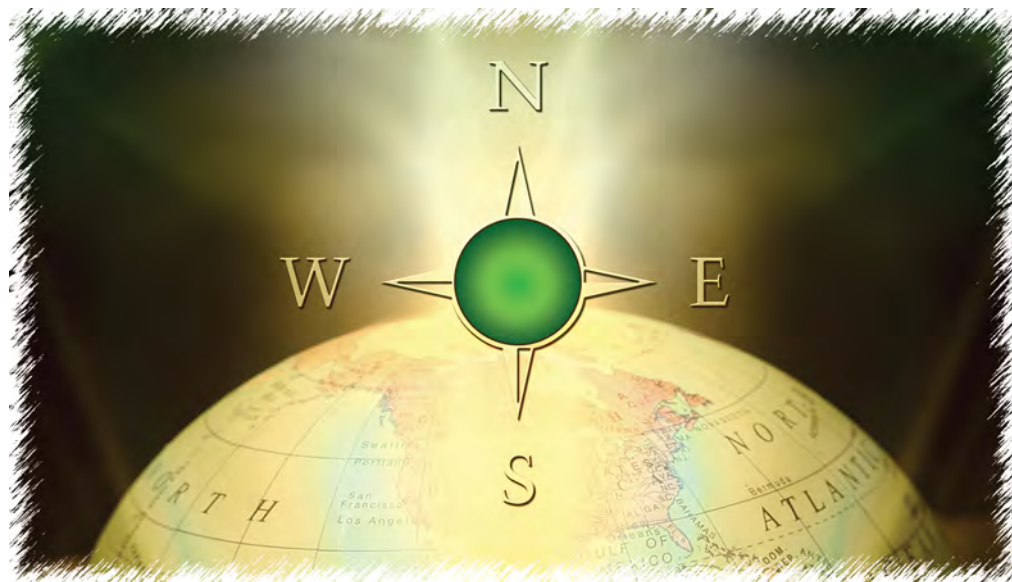

- ✓ Trail Signs
- ✓ History of the Compass
- ✓ The Basic Compass
- ✓ Orienting Your Compass
- ✓ Choosing a Sighting Point
- ✓ Finding Compass Degree Readings or Bearings
- ✓ Using the Compass
- ✓ Measurement of Distance
- ✓ Finding Directions
- ✓ Maps
- ✓ Global Positioning Systems

- Notes -









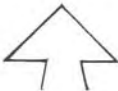

Our lives are "trail signs" to others. Where are we leading them?

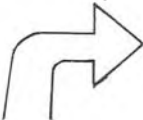
"Make Your ways known to me, LORD; teach me Your paths. Guide me in Your truth and teach me, for You are the God of my salvation; I wait for You all day long." (Psalm 25:4-5)

"I will instruct you and show you the way to go; with My eye on you, I will give counsel." (Psalm 32:8)

Trail Signs

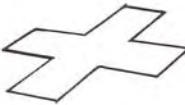
Try using the following trail signs for fun on a hike and then remember them for emergency or tracking use later.

Chalk	Rock	Grass
Straight Ahead 		
Turn Right 		
Turn Left 		
Danger or Message Left 		

History of the Compass

The first compass was a magnetized, ore-bearing rock which, when suspended on a thong or vine, would always point in the same direction.

No one knows who first discovered the compass. The Chinese seem to have understood its secrets 3,000 years ago. This was long before the Europeans learned to navigate without the aid of the sun or North Star. According to some authorities, Marco Polo brought back a knowledge of the compass from Cathay in 1260 A.D.



The north end of the magnetic needle of your compass always points to the magnetic North Pole region located in northern Canada.

Make a Simple Compass

Try making this simple compass. You will need:

- A dish of water
- A needle
- A thin flat cork
- A magnet

Follow the steps below:

- Carve a small groove in the top of the cork. Make it just large enough for the needle to fit in it.
- Rub one end of the needle on the magnet. Do not rub it back and forth or sideways. Rub the needle in one direction only, from the center to the end of the magnet. Rub it 20 or more times.
- Lay the needle in the groove of the cork.
- Place the cork and the needle in the dish of water. The needle will point to magnetic north and south.

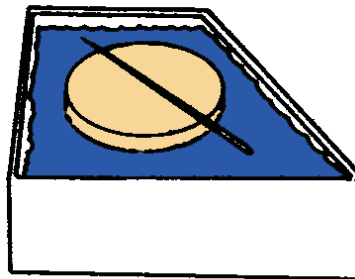
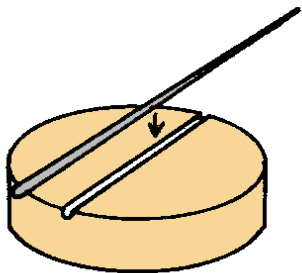
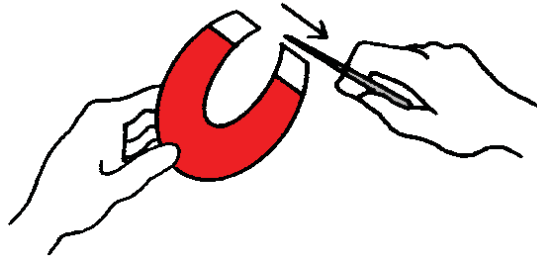
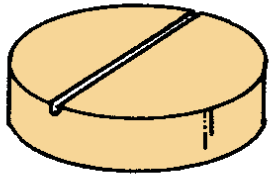

“Remember your leaders who have spoken God’s word to you. As you carefully observe the outcome of their lives, imitate their faith. Jesus Christ is the same yesterday, today, and forever.” (Hebrews 13:7-8)

- Notes -

The compass has several parts; a base, housing and three arrows. The base of the compass can be compared to our relationship with Jesus Christ since He provides our basis for life. The housing can be compared to Christian fellowship that surrounds us and provides reference points. The three arrows can be compared to the Trinity in that they work together to provide the direction that we need in our lives.

The Basic Compass

There are several parts to the basic compass. The **direction of travel arrow** is on the plastic base. This is the arrow that shows which way to walk after the compass is set.

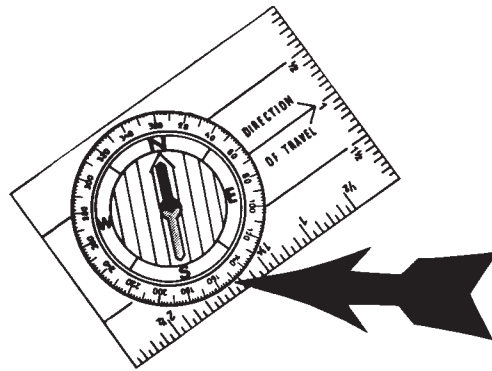
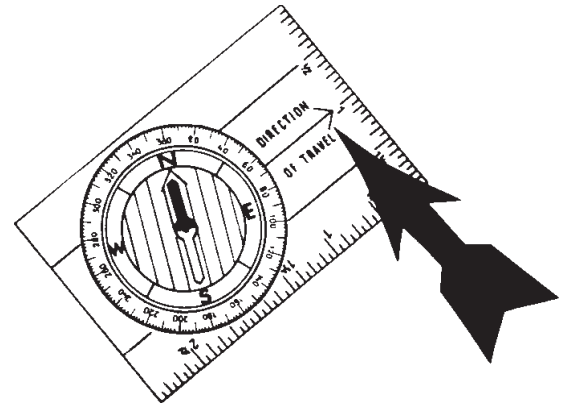

This is the **housing**. It turns - try it. The numbers around the outside of the housing are degrees. The degree number at the direction of travel arrow is the degree setting of the compass.

Inside the housing is a needle which swings on a pin. It is the **magnetic needle**. The colored end (usually red, sometimes blue) points in the general direction of North and does **not** indicate the direction of travel. The direction of travel arrow points the way to go.

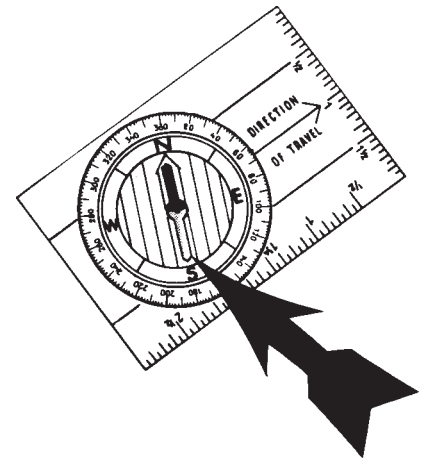

Under the magnetic needle is a colored arrow (usually red, sometimes blue). This is called the **orientation arrow**. It moves with the housing.

Be sure you know the four main parts of a basic compass, then write them below.

- 1.
- 2.
- 3.
- 4.

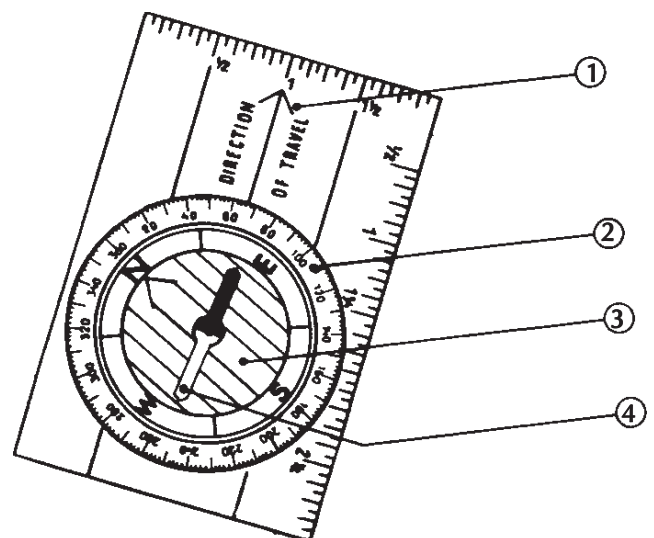

Orienting Your Compass

Orienting a compass means lining up the orientation arrow with the magnetic needle to help you determine which way to travel.

To walk north (360°):

1. Turn the **housing** of the compass so N (North) (360°) on the **housing** is in line with the **direction of travel arrow**.
2. Hold the compass with both hands, keeping your elbows tight against your sides and the **direction of travel arrow** pointing straight ahead.
3. Turn your body around until the **magnetic needle** lines up with the **orientation arrow**.
4. Walk in the direction of the **direction of travel arrow** which is pointing North.

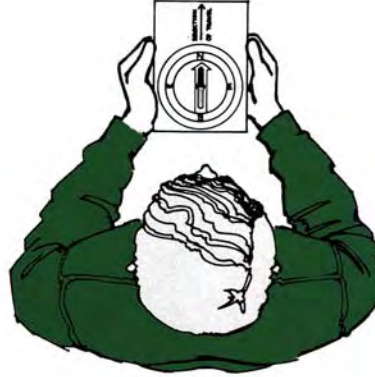

- Notes -

God's word provides direction for our lives.

*"Trust in the LORD with all your heart, and do not rely on your own understanding; think about Him in all your ways, and He will guide you on the right paths."
(Proverbs 3:5-6)*

To Walk West (270°):

1. Turn the compass **housing** until the W (270°) on the **housing** is in line with the **direction of travel arrow**.
2. Turn your body around until the **magnetic needle** lines up with the **orientation arrow**.
3. Walk in the **direction of travel arrow** which is pointed west.
4. Keep the compass oriented by keeping the **magnetic needle** in line with the **orientating arrow**.

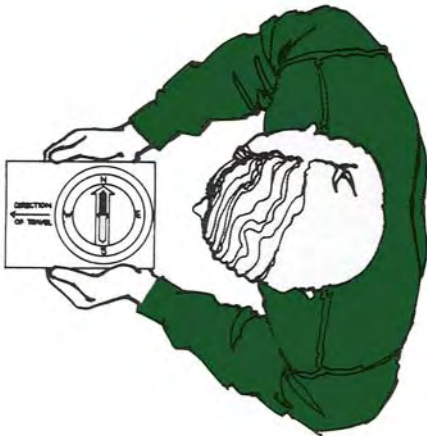

To walk any other direction:

1. Turn the **housing** so that the direction (or degree reading) in which you want to walk is in line with the **direction of travel arrow**.
2. Turn your body around until the **magnetic needle** is in line with the **orientating arrow**.
3. The **direction of travel arrow** will be pointing in the direction you wish to walk.

- Notes -

"Jesus told him, 'I am the way, the truth, and the life. No one comes to the Father except through Me.'" (John 14:6)

Keep your eyes focused on Christ.

Choosing A Sighting Point

1. Orient your compass for a desired direction such as west, for example.
2. Choose a sighting point - that is a tree, rock, house, post, or other object which is in line with the **direction of travel arrow**.
3. Walk to this sighting point.
4. Choose another sighting point which is in line with the **direction of travel arrow** and walk to it.
5. Do this each time until you reach the place you want to go.

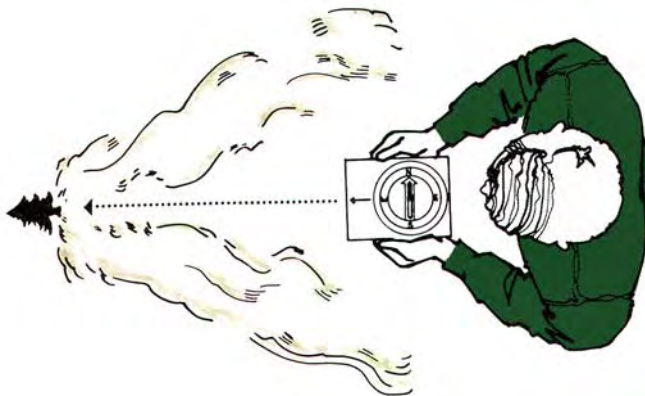

Finding Compass Degree Reading or Bearings

Look at the compass **housing**. The number and letters (20, 40, 60, etc. and N, E, S, W) indicate specific directions or bearings.

The letter "N" stands for North and its degree direction can be either 000° or 360° . The letter "E" stands for East and its degree direction is 090° . "S" is for South and its degree direction is 180° . "W" is for West and its degree heading is 270° .

Halfway between North and East would be the direction "Northeast" usually written "NE". Its degree direction is 045° . Halfway between East and South is "Southeast" or "SE" with its degree direction of 135° . Halfway between South and West is "Southwest" or "SW" at 225° and finally halfway between West and North is "Northwest" or "NW" at 315° .

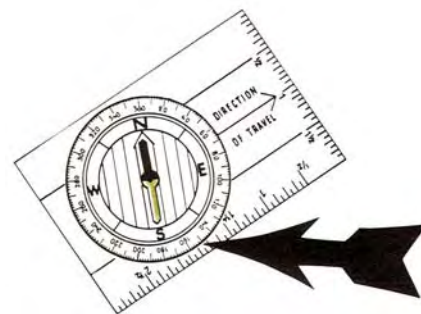

Look again at the compass **housing**. The numbers indicating the directions between North and East are usually printed as "20, 40, 60, 80." It is **highly recommended** that you get into the practice of referring to these directions as three digit numbers "020, 040, 060, 080, etc." rather than two digits. Thus, 020° would be stated a "zero-two-zero degrees." Why? Because if you always write down or say the direction as being three digits "007° - zero-zero-seven degrees" you will have less chance of making a mistake of confusing one direction with another. For example, if you saw that the direction listed on a piece of paper is "2". Is that 002° , 020° , or 200° ? There is a big difference and knowing or telling someone else the correct direction may mean the difference between life and death.

This illustration shows the four main directions with the bearing for each. Practice moving the **housing** to each direction until you know the degree reading for each. Draw on the illustration the direction and degree bearing for NE, SE, SW, and NW. Practice with a friend and answer these questions about degree reading using the compass.

- What is the degree bearing for N? _____
- What is the degree bearing for S? _____
- What is the degree bearing for E? _____
- What is the degree bearing for W? _____
- What is the degree bearing for NE? _____
- What is the degree bearing for SE? _____
- What is the degree bearing for SW? _____
- What is the degree bearing for NW? _____

Then try answering these questions with a friend.

- Which point of the compass is at 180° ? _____
- Which point of the compass is at 135° ? _____
- Which point of the compass is at 225° ? _____
- Which point of the compass is at 360° ? _____
- Which point of the compass is at 270° ? _____
- Which point of the compass is at 315° ? _____
- Which point of the compass is at 045° ? _____
- Which point of the compass is at 090° ? _____

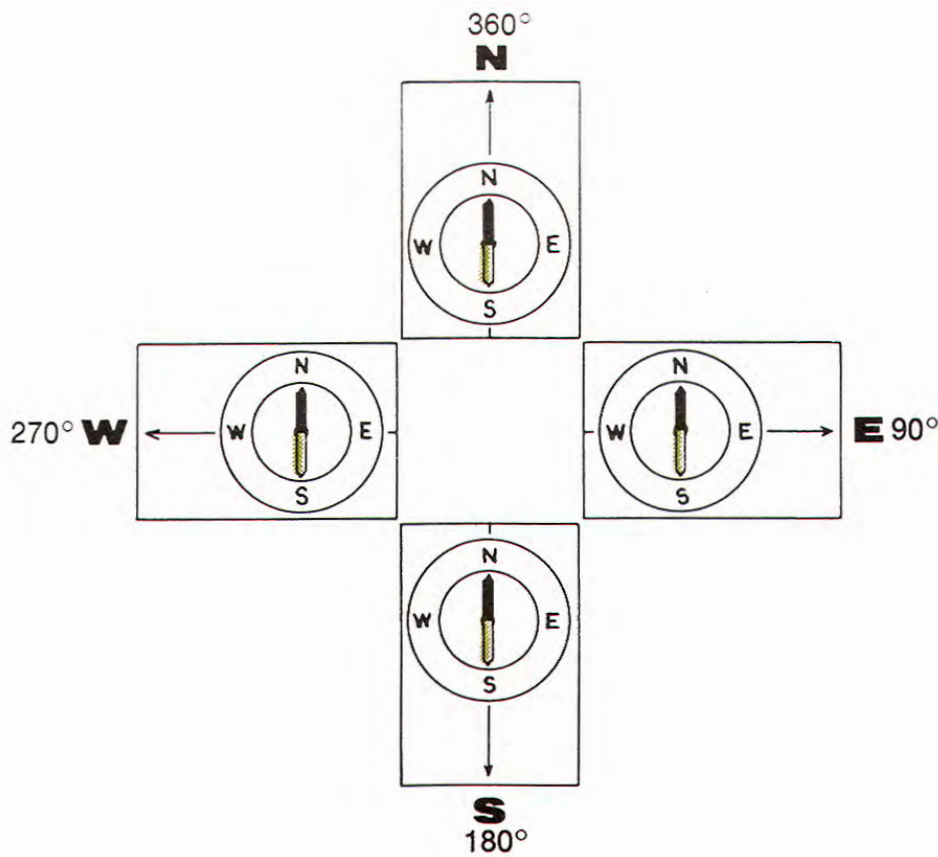

Using The Compass

Now let's practice what we have learned. We will suppose that we want to hike to a specific campsite for the night. In the woods there are no street signs or road markers to show the way, so your leader simply says that the campsite is at 055° degrees and 1000 feet from the entrance gate to the Jones farm.

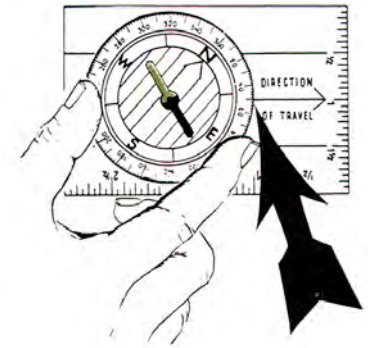

The **First** thing we must do is determine where 55° is on the compass **housing**. Between N and E the direction numbers printed on the compass **housing** are 20°, 40°, 60°, and 80°. Where is 055°? Notice on the **housing** there are a bunch of short lines, then a long line, followed by some more short lines, then another long line. This sequence repeats all the way around the **housing**. The long lines are halfway between the printed numbers so they indicate 010°, 030°, 050°, 070°, and so on until you come to 350°. This would now mean that 050° is the long line halfway between 040° and 060°. But where is 055°?



Next we must look at the groups of short lines between the long lines. When we count how many short lines there are between the long lines our answer is four. This tells us that each short line is 2 degrees (2°) from the next line. Finally we can now determine where 055° is on the housing. Look at the illustration. The long line between 040° and 060° is 050°. The short line to the right after 050° is 052°, the next short line to the right is 054° and the next short line is 056°. Where is 055°? It is halfway between the two short lines indicating 054° and 056°. Do you see that all the lines (short and long) indicate even-numbered directions such as 006°, 040°, 050°, 056°, and so on and the spaces between two lines indicate odd-numbered directions such as 007°, 041°, and 055°.



Now that we know where 055° is on the **housing**, turn it until the space between 054° and 056° is on the extension of the direction of travel arrow. The compass is now “set” - do NOT turn the **housing** any more.

Second, hold the compass level, about waist high - or a little higher - and be sure the **direction of travel arrow** points straight ahead of you - not towards you or to one side. If you hold the compass with both hands and keep your elbows tight against your sides, you will hold it much steadier.

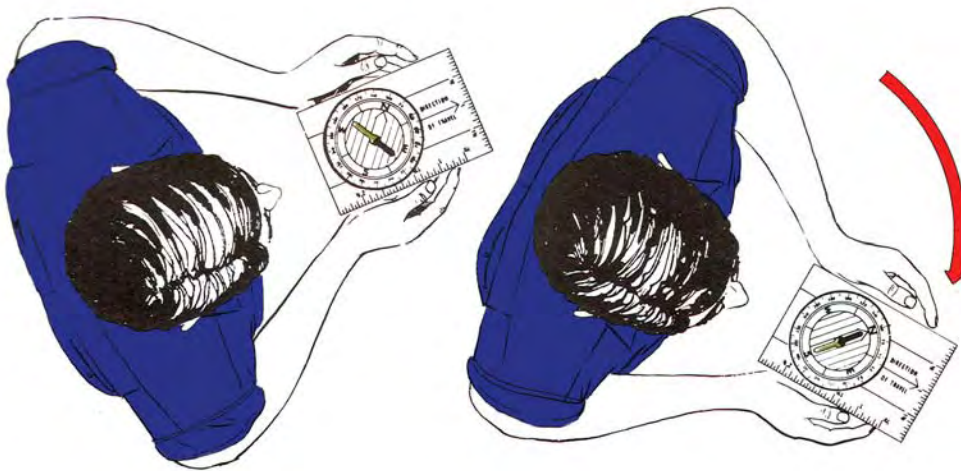

To travel in a straight line, sight on something immovable and unchanging. God is consistent and provides direction for our lives.

Third, rotate your body and watch your compass. Keep turning until the red end of the **magnetic needle** lines up with the **orientation arrow** or points to the letter N. Keep the **direction of travel arrow** pointed straight in front of you at all times. You are now facing the correct direction to walk. Look up and sight an object straight ahead, such as a tree. Then put the compass in your pocket and walk to that object. When you arrive there, repeat the process and pick out a new objective. Repeat until you reach your destination. Practice this until you can set the compass to a degree reading and determine your direction of travel.

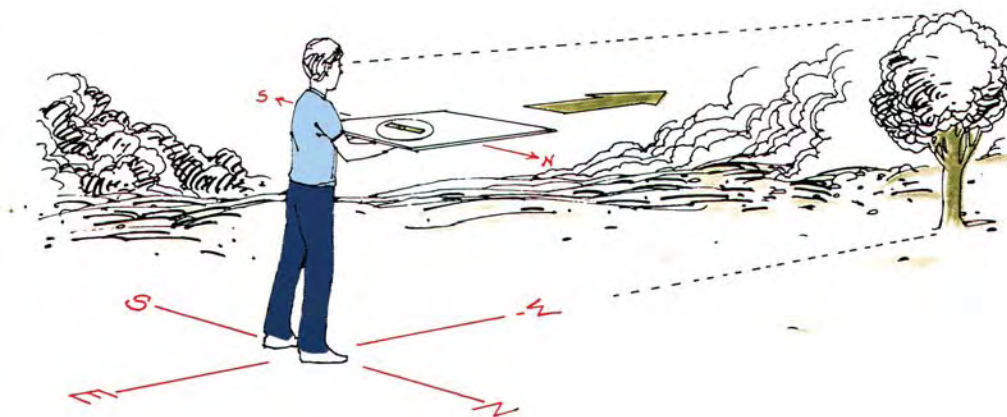

Measurement of Distance

The compass shows the direction of travel but usually it is also desirable to know how far to travel. Therefore, you should learn to measure and judge distance accurately.

Timing. One method is by timing your walk. If you normally walk 4 miles per hour, and your destination is two miles away, you will reach it in a half hour of normal walking speed. In woods or places where walking speed is more difficult, you must estimate your slower speed. If, for example, you think you are walking about one-half normal speed, you will allow yourself an hour to reach the destination two miles away.

Mental Measurement. Another method is by estimating or judging actual distances. Use several distances with which you are acquainted and apply them to unfamiliar places. For example, if you know that your home is one-fourth mile from the main road or street, you probably have a very good idea how far away one-fourth mile would be. Then use it as a mental measuring stick when judging distances. Almost everyone knows how far the length of a football field looks. It is 100 yards and you can use that as a mental measuring stick.

Stepping. For shorter distances, stepping is ideal and can be one of the most accurate methods to estimate distances. Measurement is done by walking at your normal speed and counting your steps as you walk. Then if you know the length of your step, you can convert into feet, yards, or miles as desired. For example, if the distance is 200 steps, and your step is 3 feet long, the distance is 600 feet.

Finding the Length of Your Step. Measure off a straight distance of 100 feet with a tape measure, marking each end of the distance with stones or stakes. A trip down and back will be 200 feet or 2,400 inches. Now walk down the course and back again at your normal speed, counting your total steps. Divide 200 by the number of steps you counted. This will give you the length of your steps in feet. For example, if you counted 80 steps then your step is 2.5 feet. Your stride (2 steps) would be 5 feet.

Finding Directions

By The Stars

Here is an easy method to find the North Star (Polaris). Look up in the northern sky to find the "Big Dipper." Notice that there are 3 stars in the handle and 4 stars for the pan. The 2 stars on the far side of the pan opposite of the handle (Dubhe and Merak) are called the "pointer stars" because they point almost directly to Polaris. Hold one hand up in the sky and measure how many fingers is the distance between the 2 pointer stars.

*"He counts the number of the stars; He give names to all of them."
(Psalm 147:4)*

Usually it is 3 fingers. Now move your hand so that one side of your group of fingers is up against the “lip” star of the two pointer stars. The so-called “lip” star is the one at the top or open end of the Big Dipper’s pan. Finally, in the direction that the two pointer stars are pointing measure off 5 1/2 of your finger groups and you will arrive at the North Star (Polaris). Polaris is within 3/4 degree of true, exact North. Now that you know where Polaris is you can hold a rope or straight stick on Polaris and look down at the point where the rope or stick intersect the horizon. That is North on the ground for you.

During the winter months, most of the Big Dipper is below the horizon making it difficult to locate the North Star. To find the North Star, locate the large “W” (Cassiopeia). With your arm extended, use your index and pinky fingers; place your fingers on the tips of the “W” to measure the distance. Rotate your hand using your pinky as a pivot point until the locator star is covered, then move your hand in-line twice the distance and you will be pointing at the North Star.

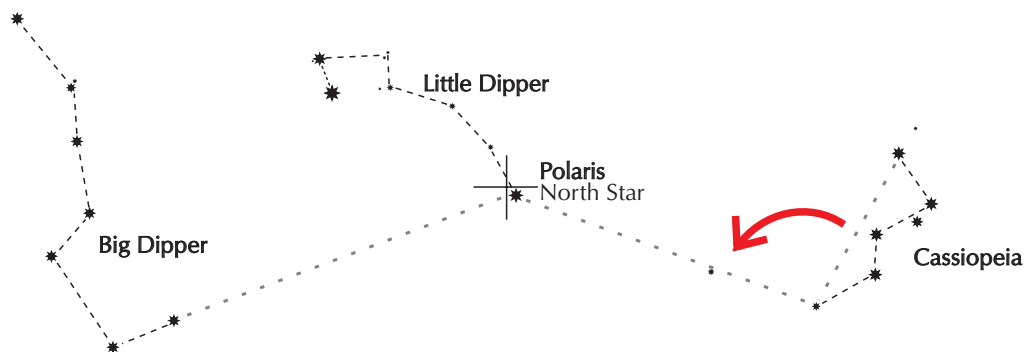

By The Sun

Generally, the sun is in the East in the morning and is in the West in the afternoon. If you face the sun in the morning, North will be on your left and South on your right; the reverse will be true if you face the sun in the afternoon. You must understand that this is not an accurate way to find directions but gives you only general directions.

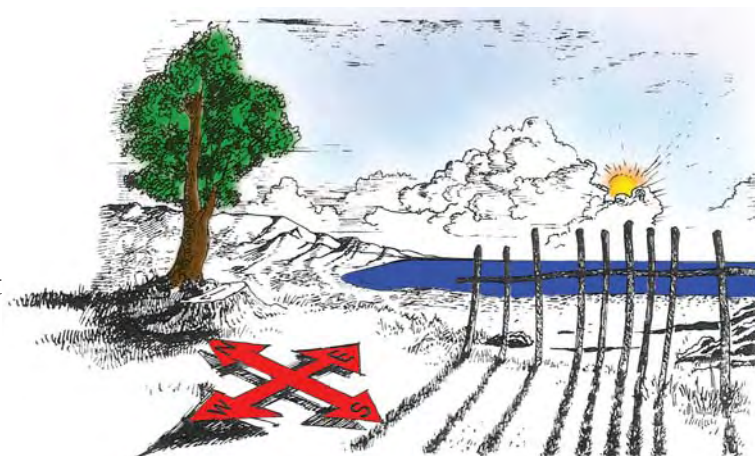

*“God made the two great lights—the greater light to have dominion over the day and the lesser light to have dominion over the night—as well as the stars.”
(Genesis 1:16)*

God has shown in nature how to find direction. His word gives direction in our lives.

*“As far as the east is from the west, so far has He removed our transgressions from us.”
(Psalm 103:12)*

*“From the rising of the sun to its setting, let the name of the LORD be praised.”
(Psalm 113:3)*

Your map is the Holy Word of God, the Bible. Follow it through life and consult it daily.

Maps

Pathfinding in the old days was an art. There seemed to be a great mystery behind the ability of the Indians, the pioneer scout, the guide, the tracker or the explorer, to find his way without using a map. The old-timer knew how to read the signs of mountain ridges, rivers, and vegetation. He watched wind directions and cloud movement. He noticed continually the position of the sun, moon and stars.

Where the old-timer learned his skill the hard way over a great number of years, the outdoorsman of today can learn the secrets of pathfinding easily with a good map and compass.

Knowledge of how to use the map and compass will help on all your outdoor activities. You will feel safer in wilderness territory. You can cut down travel distance and time with shortcuts. You can explore out-of-the-way places. You can find the way to new camp sites, lakes and exploring grounds. You can also get satisfaction from helping others in their cross-country travel.

Everyone knows what a map is, and yet, a simple definition may make map study easier. A map is a picture of the terrain viewed from above. In fact, if we photograph the ground from an airplane, we get a photomap. But photographs do not always show everything we want to know. For example, hills are not clearly visible. Roads and streams sometimes disappear beneath trees, and reappear going in a different direction. On the other hand they may show too much detail and become confusing to read. Consequently, drawn maps are often better!

A drawn map still is a picture view from above. Keep that in mind. It may emphasize the things we want to show and omit unimportant details. For example, road maps ordinarily show roads, towns, and cities, but not houses, woods, and marshes. Other maps such as topographical maps may emphasize the countryside itself. A very simple map like this one may be sufficient.



You can secure a topographical map from a map store or contact the United States Geological Survey, 1200 South Eads Street, Arlington, Virginia 22202 (for areas east of the Mississippi River) and Denver Federal Center, Denver, Colorado 80225 (for areas west of the Mississippi River).

Map Symbols

Because pictures use much space and are sometimes hard to draw, most maps use symbols to designate buildings, streams, roads and other details. These symbols have become standardized and now almost everyone drawing maps uses the same set of symbols. Most of them are very suggestive of the objects they represent. For example, a house is a black rectangular or square marking; a school is the same but has a flag on it; a church has a cross; railroads have ties; power lines have dots like poles. A contour line represents a given height. It would wind around and eventually connect to itself as it gets around the hill. Your map will tell the difference in altitude between various contour lines. So contour lines of the map will reveal not only the height of a hill but also its shape. Where contour lines are close together, the hill is steep; where they are far apart, the land is more level.



*“Very early in the morning, while it was still dark, He got up, went out, and made His way to a deserted place. And He was praying there. Simon and his companions went searching for Him. They found Him and said, ‘Everyone’s looking for You!’ And He said to them, ‘Let’s go on to the neighboring villages so that I may preach there too. This is why I have come.’ So He went into all of Galilee, preaching in their synagogues and driving out demons.”
(Mark 1:35-39)*

Map Scale

Another important part of the map is the scale. It is the device to tell “how far.” A map scale, as a rule, is located on the map or its border. It is usually divided into segments and at the end of each segment a certain distance is shown. For example, 25 feet or 1,000 yards or a mile. If, for example, the distance of one mile is written at the end of the segment, that means that the length of that segment on the map represents one mile on the ground.

Orienting the Map

It is always desirable to orient the map. Orienting a map simply means placing the map so that the northerly direction on the map coincides with the ground’s North. Maps are usually drawn with the top of the map pointing to true North (Geographic North or the Earth’s North Pole). They are usually NOT drawn pointing to Magnetic North. An orientated map always gives us a better understanding of the relationship between ground and map because the directions are then the same. There are two ways to orient a map – by compass and by inspection.

By Compass is usually a much easier and more reliable method, especially if you haven't yet identified on the map objects you see on the ground. The top of your map points in the general direction of north. The vertical lines, or Meridian lines, point to true north. Your map should show a north-south line in the margin or on the map itself. Turn the **housing** on your compass until the letter N (000° or 360°) is on the **direction of travel arrow**. Lay your compass on or near this line and then turn your map and compass together until the compass needle - or N-S line of compass - is parallel with the N-S line of your map, and the north end of the needle is pointing towards the top of the map. Try this. Your map is now orientated to within a few degrees (10°-20°) of final orientation. Now improve on the orientation by inspection.

By Inspection you can improve the orientation of your map if you are observant and look at the terrain around you and compare it with your map. When you recognize on the map the objects that you see on the ground check to see if you need to turn the map to more accurately line up those visible objects with those same object on the map.

Steps To Get Directions from a Map

Secure a topographical map of your area and use for a practice map. Determine your location on it. Determine where you want to go on the map. Follow the illustrations below.

Knowing how to use a compass and map may help find and rescue people who are lost or need to find direction. We can point them in the right direction for their lives by sharing God's Word and love.

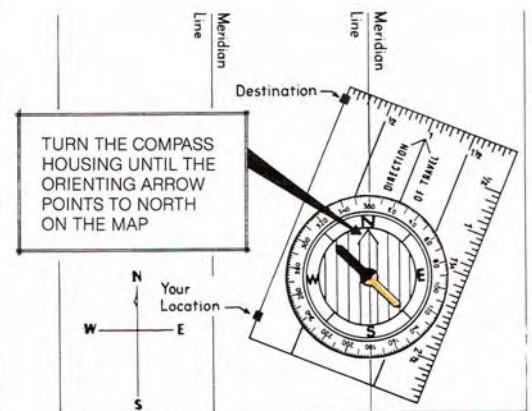
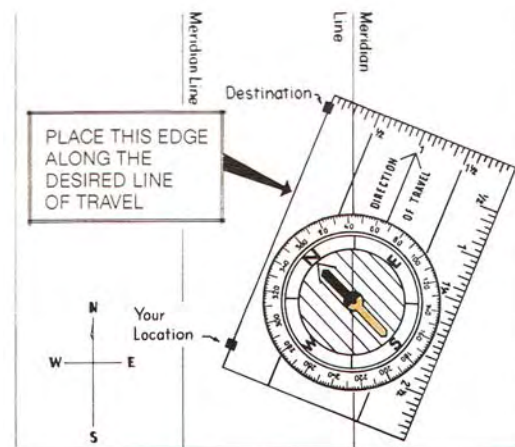

TURN THE MAP AND COMPASS HORIZONTALLY UNTIL THE RED END OF THE MAGNETIC NEEDLE POINTS TO NORTH (N) AND IS PARALLEL TO THE ORIENTING LINES

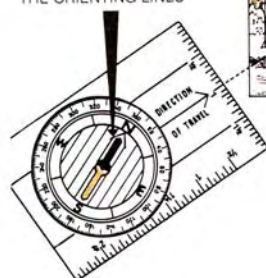

JUST FOLLOW THE ARROW!

Adjust for Declination or Variation

We have now learned how to take a bearing from a map. However, a slight readjustment of the degree reading must be made in most areas if we wish to be perfectly accurate. This readjustment is necessary because the compass needle does not necessarily point to the true geographic North Pole. It points to the magnetic North Pole which is located in Northern Canada.

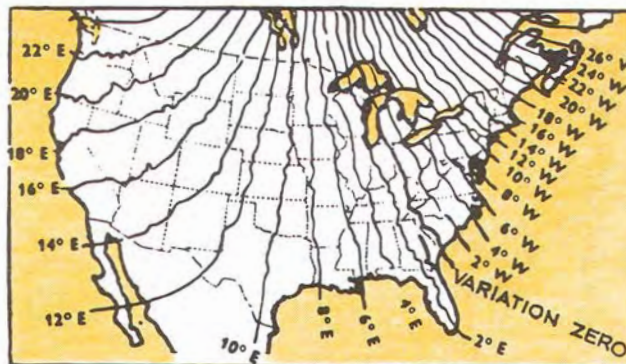
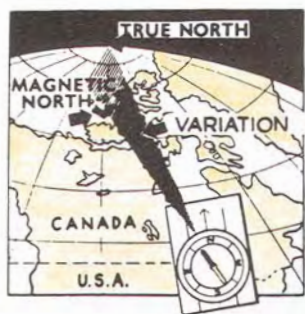

The difference between True North and Magnetic North is usually called **magnetic declination or variation** and the amount of this difference for any specific area is often shown in degrees on your map. If you happen to be on an extension of a line connecting the true and magnetic North Poles, there would be no variation and it is called the zero variation line. The zero line is not perfectly straight, but runs approximately along the eastern coast of Lake Michigan, through southeastern Indiana, through central Kentucky and Tennessee, then into northern Georgia and hits the Atlantic Ocean about two thirds of the way up the Georgia coast line. If you are located east of this line the compass needle points west of True North and is called westerly variation. If you are located west of the line, you have an easterly variation. The further away from the line you get, the greater is the variation. When adjusting the compass for this variation, first find the number of degrees of variation in your vicinity and also whether it is easterly or westerly.

If you have an easterly variation you subtract the amount of variation from the degree reading of your compass. If your compass setting is 014° and you have a 010° easterly variation, you reset your compass to 004° degrees. ($014^\circ - 010^\circ = 004^\circ$)

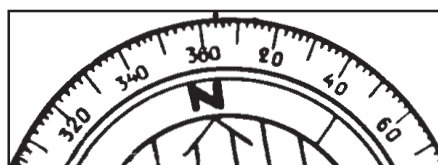
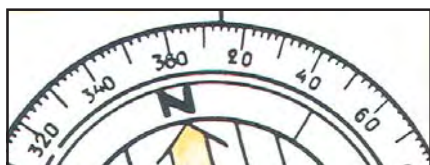

- Notes -

"Can two walk together without agreeing to meet?" (Amos 3:3)

If you have an westerly variation you add the amount of variation from the degree reading of your compass. If your compass setting is 014° and you have a 010° westerly variation, you reset your compass to 024° . ($014^{\circ} + 010^{\circ} = 024^{\circ}$)

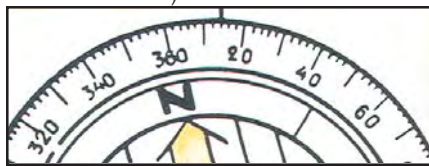

Determine your magnetic variation for your area. Secure a topographical map of your area and it will designate it. Make the necessary variation and tell the degree reading. Do this two or three times from various points on the practice map.

Global Positioning Systems

While maps and compasses have faithfully guided travelers for centuries, modern technologies have offered new means of navigating. The premier method is the NAVSTAR GPS, an acronym standing for **N**avigation **S**ystem with **T**ime **A**nd **R**anging **G**lobal **P**ositioning **S**ystem. This system, created by the United States Department of Defense, offers highly accurate, reliable, continuous 24-hour, worldwide coverage for position reporting. Now operated by the US Air Force, the system is made up of 24 satellites circling the earth about every 12 hours at an altitude of approximately 12,500 miles. Each satellite transmits a signal giving a precise timing code, the date and the current and immediate future locations of all the other satellites. GPS receivers can compute their horizontal locations on the earth by receiving signals from as few as three satellites. 3-dimensional location (the addition of altitude) is possible after acquiring a signal from a fourth satellite.



Initially used by the military and made popular in Operation Desert Storm, the airlines and ship lines quickly took advantage of the new technology. With the innovation of small and relatively inexpensive, hand-held GPS receivers, GPS is no longer just for soldiers, pilots or ship captains. In fact, GPS receivers are in cars, computers and even cell phones.

While GPS receivers are extremely accurate, they are not without limitations. Like any electronic device, they have limited battery life. GPS units also need an unobstructed view of the sky. Many GPS are marketed as water resistant, but extreme outdoor activities can cause leaks during rain or high humidity, rendering the unit useless. Dense forests, tall outcroppings or deep valleys can prevent the GPS from receiving the satellite signals. Spare batteries should always be carried and if precise navigation is required, have a back-up GPS, map and compass available.

NATURE

10



- ✓ The Cycles of Nature
- ✓ Plants Poisonous If Eaten
- ✓ Plants Poisonous If Touched
- ✓ Poisonous Snakes
- ✓ Harmful Insects
- ✓ Nature Collections
- ✓ Group Nature Activities
- ✓ Forecasting Weather
- ✓ Sharing God Through Nature

- Notes -

"For God speaks time and again, but a person may not notice it." (Job 33:14)

"Then God said, 'Let the water swarm with living creatures, and let birds fly above the earth across the expanse of the sky.' So God created the large sea-creatures and every living creature that moves and swarms in the water, according to their kinds. He also created every winged bird according to its kind. And God saw that it was good. So God blessed them, 'Be fruitful, multiply, and fill the waters of the seas, and let the birds multiply on the earth.'" (Genesis 1:20-22)

The Cycles of Nature

Plant life is the base of any food chain. Animals depend on plant life; the plant-eaters provide food for the meat-eaters. This is a typical food chain in a hardwood forest: Squirrels eat acorns; land snails and earthworms live on decayed vegetation. Beetles and mice eat plants. Toads, shrews, snakes, and birds eat insects, and with the squirrels, provide food for the red-tailed hawk.

Life in the water is based upon the water's ability to support microscopic plants. In this food chain of interdependence, plankton and algae form the base, then come fish eggs and aquatic insects, crayfish, and minnows. Frogs eat minnows, insects and crayfish and all are food for the largemouth bass and snapping turtle. Man depends on the chain for food and recreation.

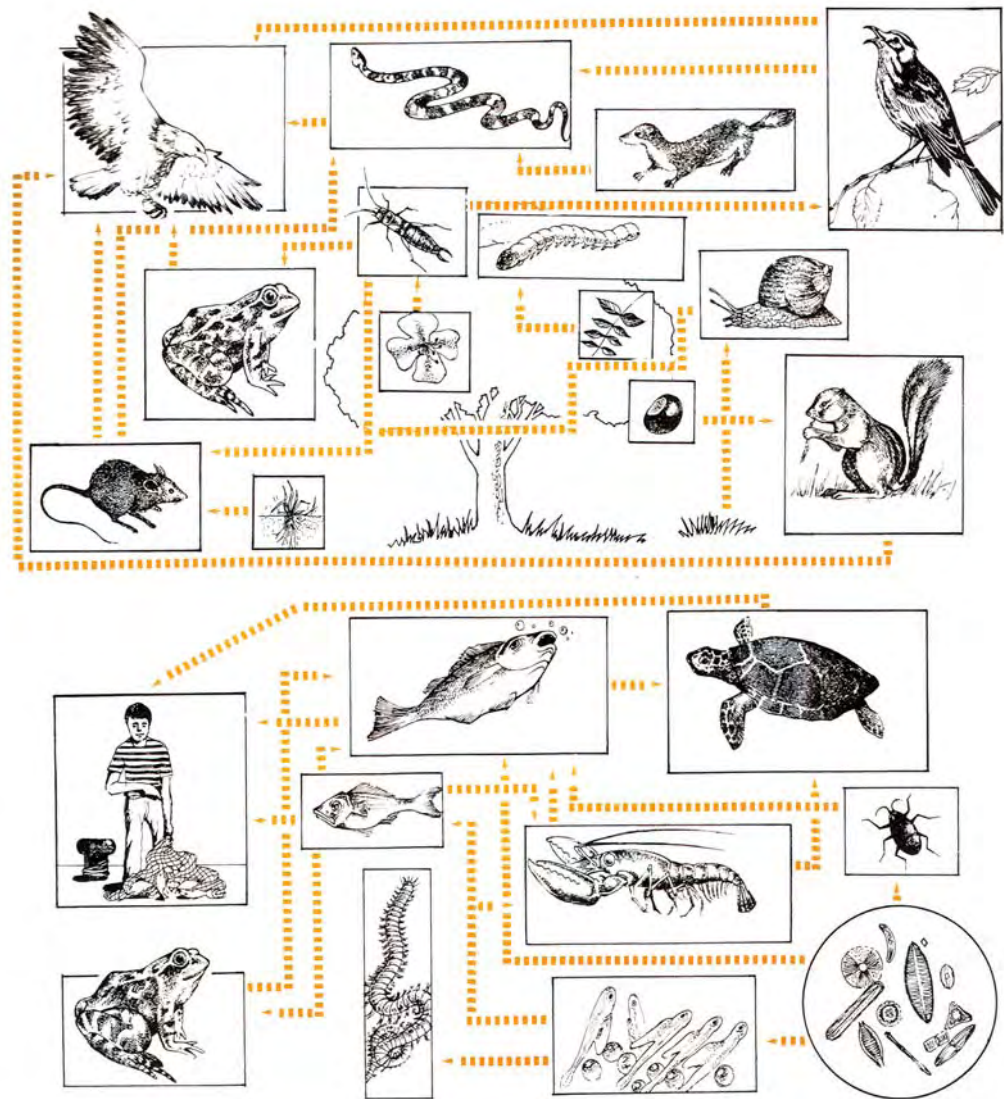

Plants Poisonous If Eaten

- Notes -

Type of Plant	Toxic Part
<i>House Plants</i>	
Hyacinth, Narcissus, Daffodil	Bulbs
Oleander	Leaves, branches
Poinsettia	Leaves
Dieffenbachia	All parts
Elephant Ear	All parts
Rosary Pea	Seeds
Castor Bean	All parts
Mistletoe	Berries
<i>Flower Garden Plants</i>	
Larkspur	Young plant, seeds
Monkshood	Fleshy roots
Autumn Crocus	Bulbs
Star of Bethlehem	All parts
Lily-of-the-Valley	Leaves, flowers
Iris	Underground stems
Foxglove	Leaves
Bleeding Heart	Foliage, roots
<i>Vegetable Garden Plants</i>	
Rhubarb	Leaf Blade
<i>Ornamental Plants</i>	
Daphne	Berries
Wisteria	Seeds, pods
Golden Chain	Bean-like capsules in which the seeds are suspended
Laurels, Rhododendron, Azaleas	All parts
Jasmine	Berries
Lantana Camara (Red Sage)	Green berries
Yew	Berries, foliage
<i>Trees and Shrubs</i>	
Wild and cultivated cherries	Twigs, foliage
Oaks	Foliage, acorns
Elderberry	All parts, especially roots
Black Locust	Bark, sprouts, foliage
<i>Plants in Wooded Areas</i>	
Jack-in-the-Pulpit	All parts, especially roots
Moonseed	Berries
Mayapple	Apple, foliage, roots
<i>Plants in Swamp or Moist Areas</i>	
Water Hemlock	All parts
<i>Plants in Fields</i>	
Buttercups	All parts
Nightshade	All parts, especially the unripened berry
Poison Hemlock	All parts
Jimson Weed (Thorn Apple)	All parts

Plants Poisonous If Touched

The following plants produce an oil (urushiol) that will cause an allergic reaction in most people. Contact with any portion of the plants can transmit the oil to skin, clothing or gear. The oil can stay active on any surface for up to 5 years. The oil on one's hands can easily be transmitted to other parts of the body. Oil on clothing can even cause a reaction to a person not directly in contact with the plant. Clothing that might have been contaminated should be handled with care and possibly washed alone. Never burn any of the plants because the oil can become airborne and cause severe respiratory reactions.



Poison Ivy is found in almost every part of the United States. Its leaves are divided into three shiny leaflets. It may be a climbing vine or a standing bush. Sometimes its leaves resemble oak leaves. It may have white berries in clusters and often red stems.



Poison Oak is a western form of poison ivy. Its leaves are oak leaf shaped. It usually grows as a shrub and may have white berries.



Poison Sumac is usually found in the eastern part of the country. It grows in swampy areas. Its leaves are divided into 7 or 13 leaflets. It may have white berries.



Poisonous Snakes

- Notes -

Rattlesnakes have tail rattles and usually give warning with them. There are many varieties in all parts of the country.



*“Now the serpent was the most cunning of all the wild animals that the LORD God had made.”
(Genesis 3:1)*



The **Copperhead** is found mostly in rocky, wooded areas. It is found in many parts of the country.

We should exercise caution in the outdoors to avoid being bitten by a snake. Jesus commanded us to be wise as serpents and gentle as a dove in Matthew 10:16.

The **Cottonmouth or Water Moccasin** is found in the south and gets its name from white inside of its mouth.



The **Coral Snake** is found in gulf coast states. It has alternating wide bands of black and red separated by narrow bands of yellow. “Red and Yellow - Kill a Fellow” “Red and Black - Friend of Jack (or Venom Lack).”

Harmful Insects

Spiders

Most spiders are helpful insects and only a few are dangerous.



The **Black Widow** is easily identified by her shiny black body and she usually has a reddish hourglass shape on the underside of her stomach. The Black Widow spins webs that lack shape and form and are erratic in appearance. The Black Widow is usually found under ledges, rocks, plants and debris piles. This spider is shy and nocturnal. She usually stays hidden, hanging upside down in her web. Although she is not aggressive, she may rush out and bite when her web is disturbed or if she becomes trapped in clothing.

Photos not to scale.

The **Brown Recluse** spider is commonly found around homes and farm buildings in the southern and central states. The mature Brown Recluse spider, also called the “brown spider” or “fiddleback spider,” has a body about 3/8-inch long and 3/16-inch wide. Its leg span is about the size of a half dollar. The color of the Brown Recluse spider varies from gray brown to deep red brown and the most noticeable mark is a dark, fiddle-shaped area on the front half of its back. This spider is not aggressive and prefers to hide in dark quiet places. It will bite if handled or when it is trapped in clothing.



The bites from both the Black Widow and Brown Recluse spiders are serious enough to require immediate medical attention. The bite of these spiders is especially dangerous to children, to the elderly, and to those in poor physical condition. However, fatalities from the bite of these spiders are very rare. Normal reactions usually include intense local pain, a blister, inflammation of the affected area, and an ulcerating sore. *Hint! Shake out clothing and shoes before getting dressed.*

Fire Ants

Fire ants and their dangers have become more prevalent in recent years. They are from 1/8" - 1/4" in size and yellowish to reddish black in color. Fire ants are found in most states. Fire ants can inflict painful stings. They can cause death to young wildlife and produce sores and nausea in humans. They are very active and aggressive.



Wasps and Hornets

A Wasp or Hornet sting can be serious, so leave them alone. The kinds of wasps and hornets include: yellow jacket wasp, black wasp, red wasp and various hornets.



Bee

The Bee is a busy, hard worker. Leave it alone and it will leave you alone. Bright, colorful clothing and fragrances will attract bees.

Mosquito

Only female Mosquitoes buzz and bite. But they are still bad pests and may carry serious diseases. Use spray or repellent.



Wood Tick

The Wood Tick can cause a serious wound and can carry serious diseases. Campers and hikers should inspect themselves daily for ticks. Remove any ticks found, clean the bite area and apply antiseptic.

Chiggers

Chiggers (or red bugs) are a real nuisance that can cause uncomfortable itching in sensitive areas like ankles, legs and the groin. Use repellent before walking in tall weeds or grass.



Scorpions

The scorpion is a unique insect that looks more ferocious than it is. Although they rarely sting unless bothered or touched accidentally (like in clothing or bedding), their sting is extremely painful. Being nocturnal, they generally hide during the day under logs or rocks.

- Notes -

"Let heaven and earth praise Him, the seas and everything that moves in them." (Psalm 69:34)

Nature Collections

Because of ecological and environmental concerns, you must be sensitive about the kinds and amounts of specimens you collect. Generally, nature should be undisturbed to help preserve the beauty and allow ecological patterns to continue naturally.

Books are good resources to learn about our natural world. Many basic nature books are inexpensive and provide interesting information.



Leaf Prints make an easy and attractive collection. Press leaves in a book to make them flat. Pin the leaf to a sheet of construction paper. To spatter, dip an old toothbrush in ink and pull a stick across the brush toward yourself. Remove the leaf and you have an attractive silhouette.

"Know Your Trees" displays are a little more involved, but help more in identifying trees. Make a plywood or cardboard background with the silhouette of a full grown tree of a particular variety. Then mount a leaf, some fruit or seeds and a piece of bark from that tree.

Casting Animal Tracks is a lot of fun for a hike. Take plaster of Paris, water, some type of mixing container, small paint brush, paper clips and cardboard strips with you into the woods. When you find a track, carefully brush away twigs and trash with the paint brush. Use a cardboard strip one and one-half inches wide and long enough to surround the track. Fasten strip with paper clip to form a dam. Push down lightly into the dirt. Mix the plaster with water until you have a thick, creamy consistency. Pour slowly over the track. After plaster hardens (about 30 minutes), lift out and peel the cardboard away. Paint it for an attractive room decoration and useful addition to your nature collection.



Butterfly Collections begin with a collecting net. You can buy one or make one out of inexpensive netting material and an old badminton racket. Sew the netting into a conical shape and then sew or weave it into the badminton racket.



The “killing jar” consists of a wad of cotton in the bottom of a jar soaked in alcohol. Drop the butterfly in the jar and quickly close the lid. He will die painlessly and quickly.

The spreading board is made with a center channel for the insect’s body. Make this by gluing two strips of corrugated cardboard on a larger sheet of corrugated cardboard. Lay the butterfly down with its body in the channel. Lay small strips of paper or lightweight cardboard over the butterfly’s wings and pin through these strips. Leave until dry, about two days.

Mount and label your collection in a small box.

The butterflies can be mounted and framed behind glass if you remove the bodies from the wings and replace with art or painted paper bodies the same size. This will make an attractive decoration for your room!

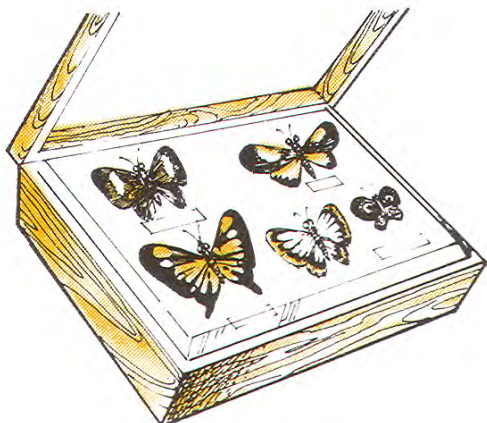

- Notes -

*“Therefore if anyone is in Christ, there is a new creation; old things have passed away, and look, new things have come.”
(2 Corinthians 5:17)*

Spider Web Collecting can be an amazing hobby. First spray the web with spray paint in a color that will contrast with the construction paper you use. Then swish the cardboard or construction paper through the web and you have a colorfully mounted spider web.



Other nature collections might include rocks, fish in an aquarium, snakes or frogs in a terrarium, flowers or other plants, insects other than butterflies, nature craft collections, nature jewelry, nature Christmas ornaments, and nature musical instruments.



Group Nature Activities

Spend time outdoors being still and reflecting upon who God is and what He has done.

Find a Treasure - Play on short walks outdoors. Each person in the group searches for his own treasure, which may be anything interesting or beautiful that is seen along the way. The treasures are not touched or collected. Instead, everyone stores them in their minds. At the end of the walk,



participants may describe the treasure in a phrase or single sentence written on a large sheet of paper passed around the group, or on individual slips of paper. The treasures may then be posted somewhere for all to read or shared aloud. With some groups, it is fun to sit down at the end of the walk and let each person tell the others about the thing he saw that he liked best. In camp, this game may be played on the way to the camp fire, with the treasures a part of the camp fire program.

Other Activities Might Include:

- Looking at everything through a magnifying glass - like a grasshopper or a spider. (Look closely at the eyes. What you see is amazing).
- Watching an ant carrying something. Watch it until it gets its load all the way home.
- Watching a bird or insect. Explain what you think it is doing.
- Watching a bird put on its "raincoat." (It pulls the oil gland back by the tail to fill its beak with oil, then passes the feathers through its bill to oil and "zip" them.)
- Taking photos of animals.

Forecasting Weather

Weather Sayings

Weather sayings are general indicators for current or upcoming weather conditions. The following have been used for many generations.

- Evening red and morning gray
are certain signs of a fine day

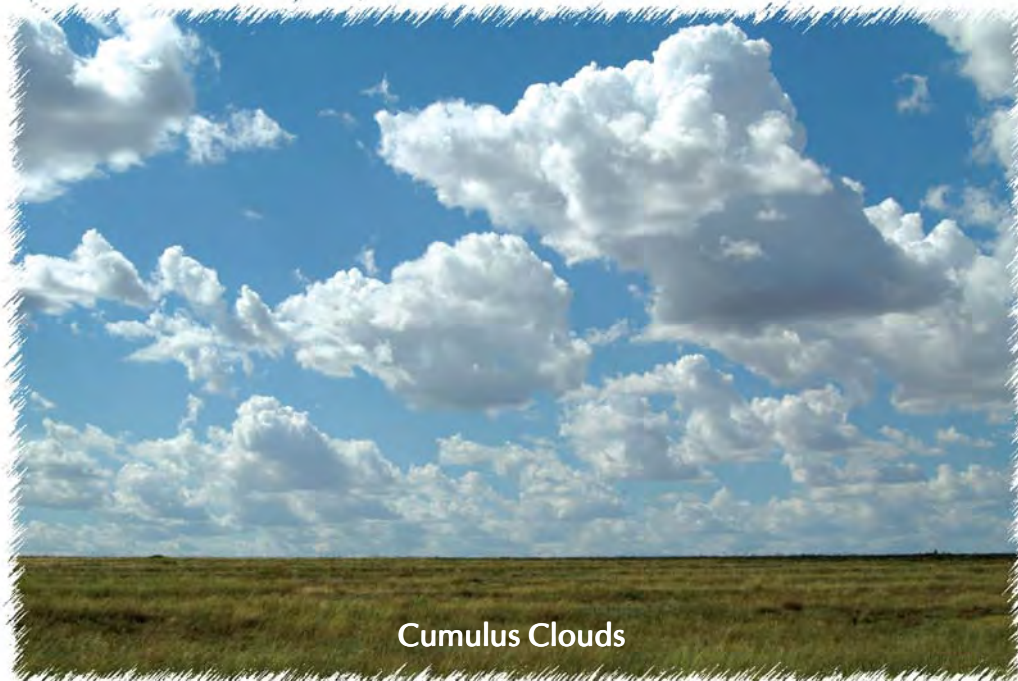

Cumulus Clouds

- Cotton floating in the air,
moderate wind and weather fair.

- Mackerel sky, storm is nigh.



*"The north wind produces rain, and a backbiting tongue, angry looks."
(Proverbs 25:23)*

- A circle around the moon tells of a storm pretty soon.

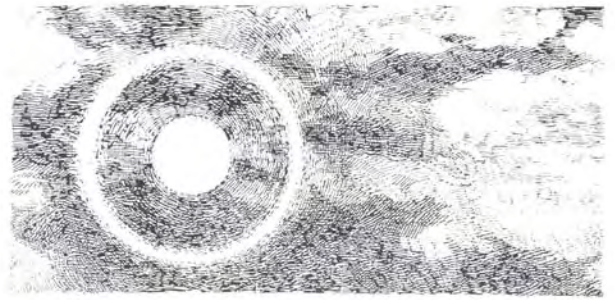

- When stars above are bright, a good day is still in sight.

- When the dew is on the grass, rain will never come to pass.

- When grass is dry in morning light, look for rain before the night.

- When the grass is dry at night, look for rain before the light.

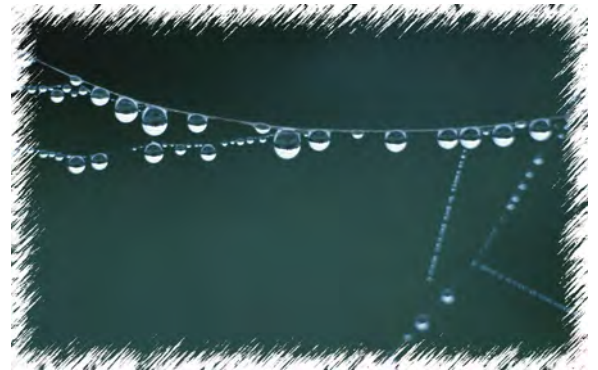

- Red sky in the morning, sailors take warning. Red sky at night, sailor's delight.
- Rain before seven, clear before eleven.
- Sounds travel far and wide, a stormy day will betide.

Weather Indicators

There are many items in nature that react to current and upcoming weather conditions. The following will help you enjoy and maybe predict the weather.

- The common dandelion is an excellent barometer when its flower has gone to seed and its top is fluffy. If it's going to be a good day, it will be round like a ball. If rain is coming, it will shut like an umbrella.



- Crickets can tell us the temperature. Count the number of chirps in 14 seconds and add 40. The total is the temperature. It's accurate 90 percent of the time.



- Clover acts as a barometer. When rain is coming, the leaves shut together and don't open until good weather is for certain. Stems of clover and many tall grasses tend to swell a day or two before a storm.

Fair Weather Signs

- Fog in the morning.
- Swallows flying high.
- Spiders very busy.
- Early morning showers.

Rain Signs

- The tree frog cries.
- Fish swim near surface.
- Flies bother you and sting you.
- Smoke beats downward.
- Low clouds move swiftly.
- Pale yellow sunset.



Weather Vane

Knowing something about the weather can be handy outdoors. Try making a weather vane. It will tell you in which direction the wind is blowing. Winds carry weather from one place to the other.

You will need:

- Heavy corrugated cardboard
 - Long thin nail
 - Wooden spool
 - 2x2 inch stick, 5 or 6 feet long
 - Compass
1. Cut cardboard in shape of arrow.
 2. Push nail through center.
 3. Place in spool.
 4. Drive long stick into the ground.
 5. Place spool and vane on stick and drive nail in center of stick.
 6. Mark directions (north, south, east, west) on each side of the stick using the compass to tell direction.
 7. Adjust so the vane turns easily.
 8. Note the direction the arrow points. Wind is from that direction.

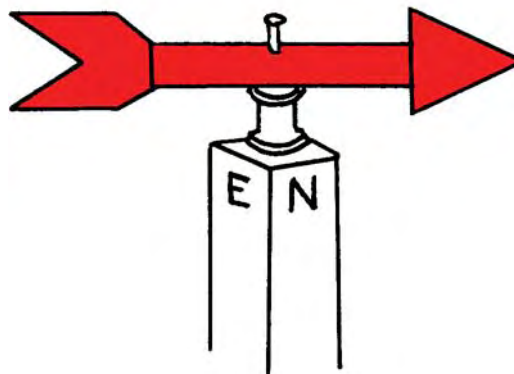

- Notes -

"LORD, our Lord, how magnificent is Your name throughout the earth! You have covered the heavens with your majesty. Because of Your adversaries, You have established a stronghold from the mouths of children and nursing infants, to silence the enemy and the avenger. When I observe Your heavens, the work of Your fingers, the moon and the stars, which You have set in place, what is man that You remember him, the son of man that You look after him? You made him little less than God and crowned him with glory and honor. You made him lord over the works of Your hands; You put everything under his feet: all the sheep and oxen, as well as animals in the wild, birds of the sky, and fish of the sea passing through the currents of the seas. LORD, our Lord, how magnificent is Your name throughout the earth!" (Psalm 8)

Clouds as Signs of What is Coming

Like frost and dew, clouds come from water vapor in the air. Many clouds are made up of tiny drops of water. They are like the little clouds of water that form near the spout of tea kettles or above the whistle of a steam engine. Other clouds are made up of bits of ice. They may be so high in the sky that the water has frozen to ice crystals like snow. If you were to go up into the cloud, you would find that it is like going into a fog because, fog is simply a cloud close to the ground. Not all clouds are alike. You have seen the big, fluffy kind and also the dark gray types. Scientists have names for many different kinds of clouds. The picture below depicts the main types. Clouds producing rain have "nimbo" or "nimbus" in their names.

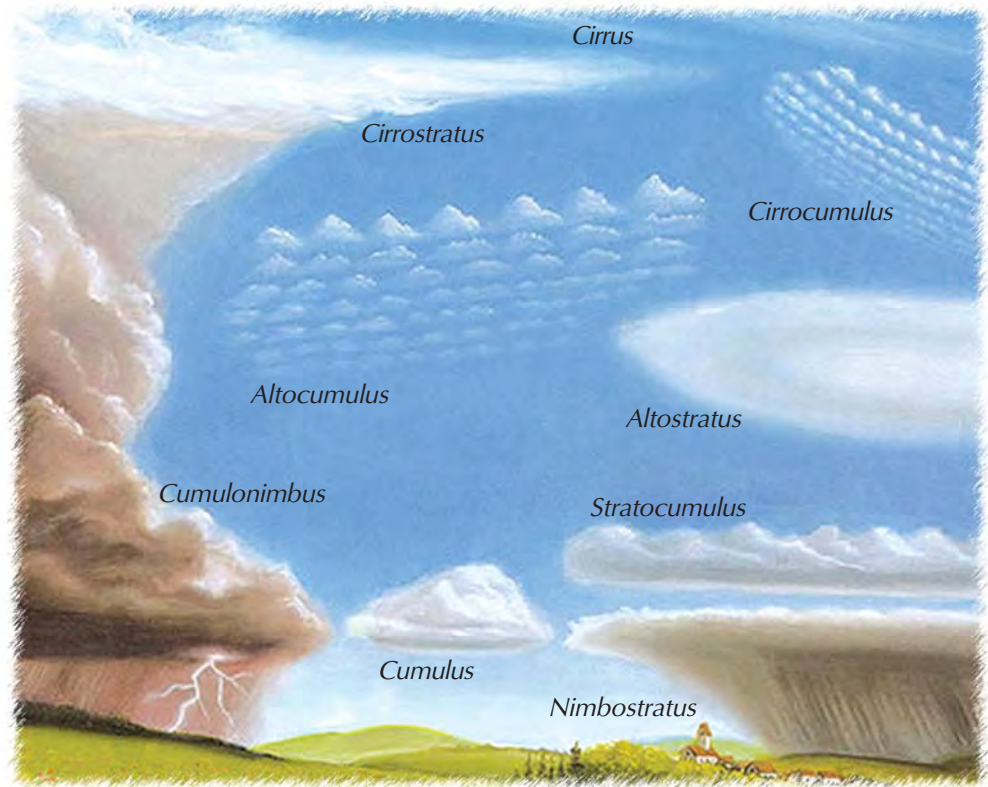

It is unlikely that all these kinds of clouds would be in one area of the sky at the same time.

Cirrus Clouds

These clouds which we see high in the sky looking like wisps or curls of white smoke are called Cirrus clouds. They are found at 30,000 feet and higher and are generally made up of ice crystals. At their high altitude they move along very fast blown by the strong winds. You have seen them with their thin, feather-like or flake-like appearance. They are usually white and fibrous and are sometimes called "Mare's Tails."



Alto-Cumulus and Alto-Stratus Clouds

Coming down a little lower, we see the middle clouds, between 5,000 and 15,000 feet altitudes. These middle clouds are either Alto-Cumulus or Alto-Stratus. The Alto-Cumulus are sheep-back-like and woolly, arranged in waves, sometimes mackerel-like. Light sprinkles of rain may fall from them. The Alto-Stratus are sheetlike clouds gray and bluish in color, through which the sun is barely seen.



Cumulus/Stratus Clouds

The lowest clouds, which we see usually from 900 to 5,000 feet are Cumulus or Stratus. Cumulus clouds are piled or heaped up in appearance. On a fair day they are the soft fluffy looking clouds at low levels and usually mean good weather is ahead. Stratus clouds are flat and layer-like in appearance. On a dark day when you expect it to rain, these clouds are the ones you see. Fog is Stratus clouds which have formed near the ground.



- Notes -

We can know about natural disasters that might occur in our area and help your family, church and community be prepared for such occurrences.

Cumulo - Nimbus Clouds

Also known as “Thunderheads” build up rapidly creating thunderstorms that generate heavy downpours. These clouds can produce high winds, lightning, large hail and tornadoes.



Sharing God Through Nature

- Notes -

- **Bat** - The radar-like actions of a bat can remind us of the importance of listening to God.
- **Porpoise** - The sonar-like actions of a porpoise can also remind us of the importance of listening to God.



"But ask the animals, and they will instruct you; ask the birds of the sky, and they will tell you. Or speak to the earth, and it will instruct you; let the fish of the sea inform you. Which of these does not know that the hand of the LORD has done this? The life of every living thing is in His hand, as well as the breath of all mankind." (Job 12:7-10)

- **Turtle Shell** - This natural protection, made by God, reminds us of His protection over His people.
- **Birds** - Consider how God feeds them. Are we not better? Matthew 6:25-26



- **Flowers in Fields** - If God clothes the fields, shall He not do much more for you? Matthew 6:28-30.
- **Bird Nests** - (a) Birds can be identified by their nests. Orioles and wrens have intricately made nests while blue jays and blackbirds have sloppy nests. We, too, can be identified by the way we build our lives and our homes. (b) As birds build their nests on rocks and in high places for safety, we find shelter, safety, and strength by building our lives on faith in Christ, close to God. Job 39:27-28 and Psalm 61:2-3.



- Notes -

“Make your own attitude that of Christ Jesus, who, existed in the form of God, did not consider equality with God something to be used for His own advantage. Instead He humbled Himself by assuming the form of a slave, taking on the likeness of men. And when He had come as a man in His external form, He humbled Himself by becoming obedient to the point of death – even on the cross. For this reason God also highly exalted Him and gave Him the name that is above every name, so that at the name of Jesus every knee should bow – of those who are in heaven and on earth and under the earth – and every tongue should confess that Jesus Christ is Lord, to the glory of God the Father.”
(Philippians 2:5-11)

- **Resurrection Plant** - Shows how water and sunlight cause growth. Use it to teach about the resurrection of Christ and of Christians.
- **Barrel Cactus and Others** - Stores water which can be used if lost in the desert. God provides! Isaiah 43:20.
- **Rocks** - (a) Israel brought 12 rocks for the 12 tribes and made a monument. (b) God is my rock and my fortress. Psalm 31:3. (c) Peter’s faith in Christ is a rock upon which Christ builds His church. Matthew 16:18.



- **Nature in General** - Makes even the invisible things of God known. Romans 1:19-20.





• **Trees** - (a) All trees bear fruit as do all Christians. (b) The kind of fruit tells what kind of tree it is as the Christian's fruit tells what kind of Christian he is. (c) Hardwoods lose their leaves in the winter and rest while evergreens and conifers are green and active year round. Some Christians take a rest like the hardwoods, and others are always active like the evergreens. Which are you? (d) Trees grow because their roots are deep to get water and minerals and their leaves are high for sunshine. Christians grow when they are rooted deep in Bible study and ready to praise God in prayer.

- Notes -

"Learn this parable from the fig tree: As soon as its branch becomes tender and sprouts leaves, you know that summer is near. In the same way, when you see these things happening, know He is near - at the door!" (Mark 13:28-29)

• **Soil or Dirt** - The parable of the sower. Matthew 13:18-23.





- **Seeds** - (a) Faith of a mustard seed. Matthew 17:20. (b) Parable of sower. Matthew 13:18-23. (c) Witnessing as seed sowing, etc. (d) Growth.

- **Weeds** - Like sin, crowd out the goodness of life.

- **Metamorphosis** - The word "metamorphosis" means change. Insects go through metamorphosis. Butterflies change from eggs to larvae to cocoons to adult butterflies. We have a type of spiritual metamorphosis when we change from a "lost" person to a Christian. 2 Corinthians 5:17.



- **Rainbows** - Now that we have looked all around us, let's look up into the sky. We see the rainbow in the sky after a good rain. If the rainbow is in the east, we will have good weather, because air currents move east. If the rainbow is at the end of the turbulence, it will be to the east of us. If the rainbow is in the west and the turbulence is moving east, we will probably have bad weather. Genesis 9:13-17.



Have you ever thought about what the rainbow is? The rainbow is God's promise to us that He will never destroy the earth again by floods. God keeps His promises. Do you keep your promises to Him?

CONSERVATION

11



- ✓ Conservation Pledge
- ✓ Conservation and You
- ✓ Good Neighbor Policy
- ✓ Fire
- ✓ Soil
- ✓ Water
- ✓ Plants
- ✓ Wildlife
- ✓ Conservation Projects

- Notes -

"God blessed them, and God said to them, 'Be fruitful, multiply, fill the earth, and subdue it. Rule the fish of the sea, the birds of the sky, and every creature that crawls on the earth.'" (Genesis 1:28)

From the very beginning of God's Creation, He made it clear we were to use and conserve all of nature, all of Creation. In other words, the conservation pledge on a world wide scale.



Conservation Pledge

I GIVE MY PLEDGE AS AN
AMERICAN TO SAVE AND
FAITHFULLY TO DEFEND FROM
WASTE THE NATURAL RESOURCES
OF MY COUNTRY - ITS AIR, SOIL,
AND MINERALS, ITS FORESTS,
WATERS, AND WILDLIFE.



"But ask the animals, and they will instruct you; ask the birds of the sky, and they will tell you. Or speak to the earth, and it will instruct you; let the fish of the sea inform you. Which of all these does not know that the hand of the LORD has done this? The life of every living thing is in His hand, as well as the breath of all mankind." (Job 12:7-10)

We should practice and encourage others to practice measures which will protect our water supply, varied plant life, soil, and wildlife. These are the national resources necessary for us to enjoy hiking and camping.

You should also learn to appreciate the wonders of God's world and develop a sense of responsibility for its care. The following are intended to help you to fully enjoy your outdoor experiences and to practice good conservation while doing so.

Conservation and You

- Enjoy the beauty of God's world by watching a sunset, a flower or a view.
- Get acquainted with something in nature - a tree, a bird, an animal, or an insect. Observe it and learn several facts about it.
- Remember that your life depends upon natural resources for food and shelter.
- Learn how the lives of other creatures depend upon these resources and upon each other.
- Keep alert to learn new things about nature and conservation.



- Notes -

Be aware of all that God has created, and worship only Him, the Creator.

"He has made everything appropriate in its time. He has also put eternity in their hearts, but man cannot discover the work God has done from beginning to end." (Ecclesiastes 3:11)



- Practice conservation in little, everyday things.
- Cleanliness and beauty are part of conservation. Keep your camp site neat and clean.
- Keep your living quarters clean and attractive.
- Pick up paper and trash found around your site no matter who left it.

- Burn or carry home all garbage and other trash from trips, cookouts, and overnight outings.
- When hiking, stay on the trails to avoid trampling plants.
- Always leave trails and camp sites cleaner than you found them.
- Do not rake around camp sites. It leads to erosion and loss of moisture around roots.

Good Neighbor Policy

There is such a thing as manners in the outdoors. All campers should know and discuss rules of hiking and camping before beginning a trip.

"Therefore, whatever you want others to do for you, do also the same for them..." (Matthew 7:12)

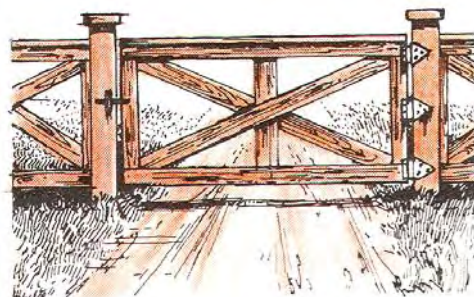

- Notes -

“Therefore He is always able to save those who come to God through Him, since He always lives to intercede for them.” (Hebrew 7:25)

The “good gardener” concept charges us with the responsibility of taking care of the resources that God has blessed us with. Be they physical or spiritual needs, we should feel that same desire in caring for the people that God puts in our lives.

If using private property:

- Obtain permission before entering private property.
- Leave gates open or closed, just as they were found.
- Treat the property with respect, leaving behind no trash or other undesirable evidence of your use.
- Don't make short cuts across private property without permission. Stay on paths or roads. Don't cut across fields of grain. Go around the edge of any planted field when there is no road or path.
- Do not pick fruit or vegetation without permission.
- On roadways walk single file facing traffic.
- Do not mark, carve, or whittle on trees, fences, or buildings.
- Report any accidental damage to property owner.



Fire

Fire is a friend, for it warms you, cooks your food and lifts your spirits. But a fire out of control is your enemy.

In Case of Fire:

- Know where the fire-fighting equipment is kept.
- Know how to use it.
- Keep it in operating condition.
- Know what to do and where to go when a fire breaks out.
- Know how to report a fire and to whom.
- Know how to provide for the personal safety of each other.



When Building Fires:

- Obtain a fire permit if required.
- Select an established fireplace, if available, rather than a new spot.
- Choose a spot well away from underbrush and trees.
- Clear the fire area and its surroundings of combustible materials.
- Select only dead wood for fires.
- Build a fire no larger than necessary.
- Keep a continuous watch on burning fires.
- Avoid building fires if the weather is windy or dry.
- Keep water, fire extinguisher, sand, broom, rakes, shovels, or other fire-fighting equipment ready for an emergency.
- Always extinguish fires before leaving camp sites.
- Extinguish fires by sprinkling plenty of water on them, and then stirring the ashes until no embers are left.
- If building fires in grassy areas, remove the sod beforehand and replace it afterwards.



Soil



- Soil erosion is one of the most common problems of camps.
- Change established paths and trails to minimize erosion.
- Especially avoid disturbing the plant cover on steep slopes.
- Build small diversion dams to stop erosion.
- Plant grass, trees or other plants on bare soil to protect it.
- Replace disturbed sod when you find it.

Water

- Clean, pure and abundant water is necessary.
- Appreciate the beauty of your water source and help to keep it clean.
- Avoid wasting water.
- On overnight camps, build temporary latrines in such a way that they will not drain into waterways and pollute them.
- Keep waterways free from garbage and trash.



*"As the water reflects the face, so the heart reflects the person."
(Proverbs 27:19)*

- Notes -

“Then God said, ‘Let the earth produce living creatures according to their kinds: livestock, creatures that crawl, and the wildlife of the earth according to their kinds.’ And it was so. So God made the wildlife of the earth according to their kinds, the livestock according to their kinds, and creatures that crawl on the ground according to their kinds. And God saw that it was good.”
(Genesis 1:24-25)

- A camp site may be used for many years. Will campers in years to come find a green and beautiful place or a bare, eroded and ugly one?
- Know your state laws protecting trees and flowers.
- Avoid thoughtless marking of living trees and shrubs.
- Know which boughs or saplings may be cut. Cut saplings selectively, so that remaining plants may be improved by their removal.
- Know which flowers are appropriate to pick.
- Know which flowers are not to be picked at all.
- Avoid overusing camp sites so that plant life will not be destroyed.
- Erect overnight camps with a minimum of clearing.
- Recognize and avoid poisonous plants.



Wildlife

- Camp sites can be a home for wild creatures where you may observe and enjoy animal friends large and small.
 - Know the kinds of wildlife found in and near your camp.
 - Know and obey fish and game laws.
 - Return fish to water if you do not plan to use them.
 - Protect the homes of wild creatures, and perhaps even plant trees and shrubs to create new homes.
 - Avoid annoying or killing small living things such as turtles, frogs, toads and non-poisonous snakes.
-
- Learn to observe the life habits of wildlife.
 - Never take from camp the small living things which make their homes there.
 - Realize that some insects are beneficial and should not be destroyed.



Conservation Projects

- Notes -

- Mark worn out camping areas to be left unused for a year or more. Move campfire circles, cookout sites, fireplaces, and tent areas to let the soil rest and make a comeback. Why not plant some native grasses?
- Place some kind of mulch around the roots of trees that are exposed because of the tramping of too many feet. This will protect the trees and prevent further erosion. Then try this around tent areas too.
- Clean up pollution in a lake or stream in your area by picking up trash along the edges and reporting industries who pollute.
- Terrace slopes to prevent erosion.
- Build erosion dams on sloping trails where erosion is possible.
- Transplant various plants from overcrowded areas to depleted areas.
- Check with the U.S. Forest Service about making firebreaks for fire control in forests and on prairies. These cutbacks can double for trails.
- Fill gullies that are eroded by building check dams. Simply drive stakes into the ground, fill with rocks, and plant honeysuckle or other vine.
- Plant trees. Memorial trees, chosen wisely, planted properly, and tended regularly make wonderful "comeback" attractions. Contact the local forester to find out before you plant what, where, and when you can replenish our natural resources with your tree. He might even come along to help.
- Talk with the U.S. Forest Service, U.S. Park Service, or state and local conservation and wildlife agencies in your area about any other conservation projects they may have for you or your group to work on.



*"First of all, then, I urge that petitions, prayers, intercessions, and thanksgivings be made for everyone, for kings and all those who are in authority, so that we may lead a tranquil and quiet life in all godliness and dignity. This is good, and it pleases God our Savior, who wants everyone to be saved and come to the knowledge of the truth."
(1 Timothy 2:1-4)*



“Then God said, ‘Let Us make man in Our image, according to Our likeness. They will rule the fish of the sea, the birds of the sky, the animals, all the earth, and the creatures that crawl on the earth.’ So God created man in His own image; He created him in the image of God; He created them male and female. God blessed them, and God said to them, ‘Be fruitful, multiply, fill the earth, and subdue it. Rule the fish of the sea, the birds of the sky, and every creature that crawls on the earth.’ God also said, ‘Look, I have given you every seed-bearing plant on the surface of the entire earth, and every tree whose fruit contains seed. This food will be for you, for all the wildlife of the earth, for every bird of the sky, and for every creature that crawls on the earth—everything having the breath of life in it. I have given every green plant for food.’ And it was so.”

(Genesis 1:26-30)



FUN & WORSHIP

12



- ✓ Leading Games
- ✓ Games
- ✓ Global Games
- ✓ Leading Songs
- ✓ Mission Stories
- ✓ Camp Worship Ideas
- ✓ Camper's Prayer
- ✓ Conducting Flag Ceremonies
- ✓ Verses and Mottos

Leading Games

Games help us to start building relationships with one another. They can be a way of introduction and a healthy way to release energy. There is a certain art to playing games that must always be present. Clearly defined rules, a definite ending and beginning, and proper adult supervision are essential to a successful game.

Before starting a game clearly define the rules. Assume that no one knows the rules. Adapt the rules to fit the group to make it fair for everyone playing. (For example, if older and younger children are playing kickball, have the older children kick the ball with their opposite foot to give the younger children an even playing field.) If possible, demonstrate how the game is played.

The person leading the game should maintain control either by voice or with a whistle. The leader should avoid playing in the game so that he can supervise the activity. It is also important to give different people an opportunity to be "It" or play the lead role in a game. Always seek to involve everyone. A good rule of thumb is to end any game or activity while everyone is still having fun. If participants do not become tired of a game they will be eager to play it again.

Prepare a list of games to play and plan more games than time allows. Seek to play games that are not normally played at home.

No matter what game is played, make it as fun as possible! Game books and the Internet are good sources to find new, exciting activities.



The Difference Between Sports & Games

- Notes -

Sports

Sports generally:

- Have definite, universal and unchangeable rules.
- Limit the number of players at a time.
- Place an emphasis on winning.

Games

Games usually:

- Have adaptable rules that fit players and needs. Equipment can be adapted to specific situations.
- Allow any number of players.
- Place an emphasis on having fun.
- Are best suited for camping activities.

Games



Dragon's Tail

Divide group into equal teams (can be any number of teams and number of people in them). Assign a "head" and a "tail" to be at the beginning and end of each team. Each team should line up behind one another, facing the person in front of them with

the "head" of the "dragon" at the front of the line. Each person should hold onto the shoulders of the person in front of them. When the leader says "Go!" the "head" tries to tag another teams' "tail." A team is "out" if their "tail" is tagged or if the team breaks apart.



Stand Up

Divide group into pairs. Have them sit back-to-back and link arms. The challenge is to push against each other until they are standing up. Using hands to push themselves up is against the rules!

Steal the Bacon

Divide the group into two teams and number them off.

Line the team members up shoulder-to-shoulder, with the teams facing each other, about twenty yards apart.

Use an object like a

handkerchief to be the "bacon" and place it on the ground in middle of the two groups. All team members must stay behind a line and run and try to "steal" the bacon only when their number is called. The leader will randomly call out numbers. The object is to get the "bacon" back to the team line before being tagged by members of the other team. A point is scored for returning to the team line without being tagged and a point can be scored by tagging a person before he can get back to his team. Try calling out several numbers at one time, but make sure everyone is safe!



Toilet Tag

In this tag game, one person is designated as "It" and tries to tag everyone he can. Once a person has been tagged, he must kneel on one knee and raise one hand to eye level. To become unfrozen, another person must sit on the person's leg and "flush" him by pulling his hand down and making a flushing sound. Make sure to have clearly defined boundaries. Try changing the person playing "It" several times.

Elbow Tag

This is another tag game where people are divided into groups of two's or three's linked at the arms. Arrange these groups in a circle with plenty of running room. Choose one person to be "It" and

another person to be chased. "Base" is all the groups. By linking arms with a group, the person being chased is safe from being tagged. The person on the end of the group suddenly becomes the new person being chased. This new person can link with another group and the person on the opposite end becomes the new person being chased. Change the person who is "It" often.



Ohayo-Konichiwa! (Japanese Game)

Arrange participants into a circle. Have "It" walk around outside the ring and tap another player, saying "Ohayo" (pronounced like the state Ohio), which means "Good Morning" in Japanese. "It" begins running around the circle one direction and the one tapped runs around the circle in the opposite direction.



When the runners meet, they stop, shake hands, and bow from the waist three times saying "Konichiwa!" ("koh-nee-chee-wah"), which is "Good Evening!" and continue running to reach the vacant space. The last one to get there becomes "It" and the game continues.

Chicken Eating Corn (Chinese Game)

A dozen items (corn, beans, etc.) are placed on the floor in front of each player. He cups his hands, with the first fingers placed against each other to represent the beak of a chicken. Pick up the items, one by one, with the "beak" and drop them into your cupped hands, representing the bird's stomach. First to finish wins.



Chinese Tag

Choose someone to be "It." He chases the others around the room trying to tag them. When tagged, a person must hold the spot where he was tagged with his right hand and begin chasing others.



- Notes -

"Shout joyfully to God, all the earth!" (Psalm 66:1)

Oriental Self Portraits

Appoint one player as an instructor and the rest become artists. Give the artists a marker and a paper sack. Have the artists put the paper sacks over their heads. The instructor then directs artists in painting their faces by giving commands like, "paint the left eye," "the right ear," "the nose," etc. When completed, the instructor has the artists remove and enjoy the masterpieces. A variation of this is to pair off and have the artists paint each other's face.



Pebble Game (Greece)

Place two to six small pebbles on back of the hand. When a signal is given, turn the hand over and catch as many as possible with the same hand.

The Man, The Tiger, And The Gun (Argentina)

Divide the campers into two groups facing each other. Have groups go into huddles to decide what they are to represent, either a Tiger, Gun, or Man. The two groups face each other again, and at a signal, each person in the group gives the sign which the group agreed upon.

The Tigers raise their hands shoulder high and show claws and teeth. For the Man, cross arms haughtily over the chest. Point an arm for the Gun. Points are earned as follows: The Tiger kills the Man; The Gun shoots the Tiger; The Man operates the Gun. Groups huddle again after facing each other and decide on another sign or the same sign. Play until one group has ten points.



Leading Songs

Songs are a great way to unite groups. Songs with hand motions are great for boys. It is important that the leader of the song be enthusiastic and assistants are helpful in motivating the group. Make sure everyone participates. First, introduce the song to the group by singing the song and demonstrating the hand motions.

Next, have the group join the leader in singing the song. Pre-plan for a song service by making a list of songs, hand motions, and any other important aspect. Use the Internet and song books to locate appropriate songs, tunes, and lyrics. *Hint! The song leader should never ask "Do you know this song?" Instead, he introduces a new song by saying, "We're going to sing this song, and this is how it goes."*



There are several types of songs that can be used in outdoor experiences during appropriate times and activities. These types include:

- Fun songs
- Patriotic songs
- Motion songs
- Vesper songs
- Tripping songs
- Worship songs

Tripping Songs

Songs can be sung on the trail to help set a cadence for the trip. Listed below are some traditional hiking and river songs. Encourage your group to create their own hiking song.

I'm Happy When I'm Hiking

Tramp, tramp, tramp, tramp,
Tramp, tramp, tramp, tramp,
I'm happy when I'm hiking,
Pack on my back.
I'm happy when I'm hiking,
Off the beaten track.

Out in the open country,
That's the place for me
With a Christian friend,
To the journey's end,
10, 20, 30, 40, 50 miles a day.
Tramp, tramp, tramp, tramp, (repeat)

The Paddle Song

Our paddles keen and bright
Flashing like silver
Swift as the wild goose flight
Dip, dip and swing.
Dip, dip and swing.

Dip, dip and swing them back
Flashing like silver
Swift as the wild goose flight
Dip, dip and swing.
Dip, dip and swing.

Vesper Songs

Taps

Day is done,
Gone the sun,
From the lake,
From the hills,
From the sky,
All is well,
Safely rest,
God is nigh.

Fading light,
Dims the sight,
And a star,
Gems the sky,
Gleaming bright,
From afar,
Drawing nigh,
Falls the light.



Mission Stories

There are so many possibilities for mission stories it would be impossible to even print a representative sampling in this manual. Save current and back issues of mission education magazines to use as a resource for selecting a mission story. Invite someone who has been involved in missions to join you on your campout and share about their experiences. Share with others the mission experiences that you or campers have had.

“As He was getting into the boat, the man who had been demon-possessed kept begging Him to be with Him. But He would not let him; instead, He told him, ‘Go back home to your own people, and report to them how much He has had mercy on you.’ So he went out and began to proclaim in the Decapolis how much Jesus had done for him, and they were amazed.”
(Mark 5:18-20)



Camp Worship Ideas

- Notes -

- **Morning Watch** is a brief time before breakfast for a scripture reading and/or thought and prayer. Capitalize on nature!



- **Personal Quiet Times** should be encouraged so that each person can spend time alone with God each day.
- **Sealed Orders** is another approach to personal devotional times. Each person receives a sealed envelope which he takes off somewhere alone. In it are instructions for a brief Quiet Time with scripture reading suggestions, prayer suggestions, a question, a thought for the day, etc.
- **Letter to Myself** is another way of personal private involvement. Each person writes a letter to himself about a decision while at camp or something he hopes to continue doing in the future as a Christian. He seals it in a self-addressed envelope and it is mailed to them several months later.
- **Spontaneous Worship** is when something happens in camp or is seen along the trail unexpectedly that calls for either discussion, prayer, singing or reverence. A sensitive leader will be alert to these possibilities.
- **Activity Devotionals** are based on the activities of the day in camp such as relating a map and compass lesson to the direction Jesus gives to life or a fire craft activity to witnessing, etc. (Also known as spiritual applications.)
- **Camp Fire Services** are a great time to gather around a fire and spend time worshipping together. Begin with a campfire lighting ceremony. Have someone lead in 2-3 worship songs or choruses. Have campers present a Bible drama, story or skit that had been previously prepared. Costumes and props are an effective addition if available. The leader should briefly summarize the meaning or application of the drama. Close with a time of invitation (if appropriate) and prayer. Remember the campfire motto - KISS (Keep It Short & Simple).

"Yet He often withdrew to deserted places and prayed." (Luke 5:16)

"As a deer longs for streams of water, so I long for You, God. I thirst for God, the living God. When can I appear before God?" (Psalm 42:1-2)

- Notes -

"Let all people be silent before the Lord, for He is coming from His holy dwelling."
(Zechariah 2:13)

Camper's Prayer

Our Father: We thank you for the beauty of this unspoiled world; for the lakes and the trees, the rocks and the stars which chart the way to heaven. May we appreciate it to such an extent that our presence here shall not detract in any way from the beauty that was here before we came.

Grant us health, that we may be able to get the most out of this camping experience.

Give us the willingness to do our full share of the work of the day.

Give us, our Father, the physical courage to meet whatever emergency may arise; to bear pain bravely, if necessary. Give us the moral courage to say "No."

Guard us from boastfulness, intolerance, and deceit - and never permit us to forget that we are here under peaceful skies because others died to make it so.

Protect us, dear God, through the hours of the day and the darkness of the night, that we may return at the conclusion of this happy experience, better than when we left, to those who love us.

We ask this in the name of Christ Jesus. AMEN



Conducting Flag Ceremonies

The following information provides a brief overview of how flag ceremonies should be conducted.

Flag Raising Ceremony

Conducted at the beginning of an event and the start of each camp day. Flags are posted with honor and respect. Ensure that flags never touch the ground and are displayed correctly. The U.S. flag is always posted in a position of honor to other flags, either in the center and higher than other flags or to the far right side of the flags (the flag's own right - left side of audience). Flags should be hoisted briskly and lowered slowly with dignity. For more information concerning handling the U.S. Flag, consult the Flag Code.

Order of Service

Raising of Flags
Pledge to the U.S. Flag (Everyone)
Pledge to the Christian Flag (Everyone)
Pledge to the Bible (Everyone)
RA Pledge (Everyone)
Challenger Verse (Challengers)
Conservation Pledge (4th grade and above)
Missionary Prayer Calendar
Morning Prayer
Announcements
Motto (Optional)

Leading the Event

(Camp Attention)
(Attention - Salute - Pledge)
(Attention - Salute - Pledge)
(Attention - Salute - Pledge)
(Attention - Pledge)
(Attention - Repeat After Me)
(Attention - Pledge)
(Persons assigned this task)
(Persons assigned this task)
(Persons assigned this task)
(Join me in saying the motto)

Flag Lowering Ceremony

Conducted at the end of an event or towards the end of each camp day. Flags are lowered slowly with dignity and folded once received. Ensure that each flag does not touch the ground. The U.S. Flag is folded with a triangle fold (13 folds). Other flags are folded with a square fold. Consult the Internet for more information on the flag folding ceremony.

Order of Service

Lowering the Flags
Evening Prayer
Announcements
Motto (Optional)

Leading the Event

(Camp Attention)
(Persons assigned this task)
(Persons assigned this task)
(Join me in saying the motto)

Flag Retirement Ceremony

A flag that shows signs of wear and tear should be retired from service. A retired flag can either be presented to an individual or destroyed in a ceremony that shows honor and respect to the flag being retired. United States Federal Law provides that "The flag, when it is in such condition that it is no longer a fitting emblem for display, should be destroyed in a dignified way, preferably by burning." (36 U.S.C. 176(k)) Take time at the beginning of the ceremony to explain that the flag is being retired with respect and honor and that this is not a Flag Burning Ceremony.

Verses and Mottos



Royal Ambassadors Motto
We are Ambassadors for Christ
(2 Corinthians 5:20)

Lad Motto
Learn and Do in Jesus' Name

Crusader Motto
Help Others in Jesus' Name



Challenger Motto
Where Missions and Ministry Meet

Challenger Verse
"Therefore, my dear brothers, stand firm. Let nothing move you. Always give yourself fully to the work of the Lord, because you know that your labor in the Lord is not in vain."
(1 Corinthians 15:58)

APPENDIX



- ✓ Campcraft Training
- ✓ Spiritual Markers
- ✓ Chapter Pledges
- ✓ Medical Release
- ✓ Scripture References

Royal Ambassador - Challenger Campcraft Training

The Campcraft training program is designed to introduce structured camping experiences that challenges the boy or young man to discover their importance and inter-relationship with the created universe and a Creator who has a purpose for their life. The following pages detail the standards used in each level of the campcraft program and are used in conjunction with the Campcraft manual to introduce the learner to the outdoor living skills in addition to recording their progress.

Those skills will enable all to be able to experience many fun and exciting outdoor and camping experiences. These can develop into life-long activities.

Leaders who have an interest in advancing in their camping skills in order to teach these skills to the boys and young men are encourage to attend the Leadership Training Camp which is conducted each year during the first full week of June at Latham Springs Baptist Encampment. For further information contact the Royal Ambassador / Challenger Director at (214) 381-2800.



Discoverer 1



Date Initials

Trip Planning

_____ _____
a. Help plan and take a picnic

Equipment and Shelter

_____ _____
a. Learn and demonstrate how to make your bed.

Rope Craft

_____ _____
a. Learn and demonstrate how to tie your shoelaces.

Tool Craft

_____ _____
a. Learn and demonstrate how to use and care for a flashlight.

Fire Craft

_____ _____
a. Demonstrate how to call the fire department in an emergency.
Post the number near your phone.

Cooking

_____ _____
a. Help prepare a meal.

First Aid

_____ _____
a. Demonstrate how to properly apply a plastic bandage.

Safety and Sanitation

_____ _____
a. Show that you have made a habit of picking up and putting away dirty clothes daily. Keep a record of your activity for 3 weeks.

Map and Compass

_____ _____
a. Learn and recite your home address.

Nature

_____ _____
a. Take a nature walk in your neighborhood. Identify birds, insects, and animals on your way and draw pictures of them.

Conservation

_____ _____
a. Show you have made a habit of turning off your light switch to save energy. Keep a record of your actions for three weeks.

Fun and Worship

_____ _____
a. Draw pictures of three things God has created.

_____ has completed the requirements for the Discoverer 1 patch.

Date Completed _____ Signed: _____ (Leader)

Discoverer 2



Date Initials

Trip Planning

- ____ ____ a. Plan and conduct an outdoor trip.
____ ____ b. Plan and conduct a trip to a local attraction, such as a museum, ball game, or zoo.

Equipment and Shelter

- ____ ____ a. Make a fun shelter from a large cardboard box.
____ ____ b. Draw a picture of three different types of shelters.

Rope Craft

- ____ ____ a. Unravel a piece of rope and explain how it is made.
____ ____ b. Explain three different ways to use rope.

Tool Craft

- ____ ____ a. Demonstrate how to properly drive a nail or a tent stake with a hammer.
____ ____ b. Make a canteen for a hike.

Fire Craft

- ____ ____ a. Visit your local fire department.
____ ____ b. List the things in your house that burn.

Cooking

- ____ ____ a. Help make a weekly grocery list and plan a trip to the grocery store.
____ ____ b. Help plan a menu for a cookout.

First Aid

- ____ ____ a. Demonstrate how to call your local medical emergency unit. Post the number near your phone.
____ ____ b. Talk about what to do when someone has an accident.

Safety and Sanitation

- ____ ____ a. Show that on every outdoor trip you have made a habit of fastening your seat belt. Keep a record of 10 trips.
____ ____ b. Find two ways to get out of your house in case of fire.

Map and Compass

- ____ ____ a. Draw a map of your backyard, neighborhood, church, or school.
____ ____ b. Discuss what to do if you become separated or lost.

Nature

- ____ ____ a. Make and collect at least three tree bark rubbings. Identify the trees from which they came.
____ ____ b. Create an animal, car or other creation out of rock with paint and glue.

Conservation

- ____ ____ a. Pick up litter in your yard or neighborhood.
____ ____ b. Learn ways to conserve water and demonstrate them.

Fun and Worship

- ____ ____ a. Write a prayer of thanks for the outdoors as a letter to God.
____ ____ b. Learn and play a travel game that you could play in a car or on an outdoor trip.

_____ has completed the requirements for the Discoverer 2 patch.

Date Completed _____ Signed: _____ (Leader)

Discoverer 3



Date Initials

Trip Planning

- _____ _____ a. Plan to visit a city, state, or national park.
- _____ _____ b. Visit a dam, power plant, or electric company.
- _____ _____ c. Plan and visit a local factory or work place.

Equipment and Shelter

- _____ _____ a. Discuss and assemble an Emergency Auto Kit for your car.
- _____ _____ b. Collect 5 pictures of different shelters.
- _____ _____ c. Explain how to dress for different weather/climates.

Rope Craft

- _____ _____ a. Make a collection of at least five different ropes.
- _____ _____ b. Illustrate the history of rope with a drawing or model.
- _____ _____ c. Demonstrate how to care for rope.

Tool Craft

- _____ _____ a. Demonstrate safe use of a hand-operated can opener.
- _____ _____ b. Make a tool apron or a tool storage roll.
- _____ _____ c. Demonstrate how to use and care for a shovel.

Fire Craft

- _____ _____ a. Explain the safety rules for campfires
- _____ _____ b. Make a buddy burner or homemade fire starter.
- _____ _____ c. Tell some good and bad uses of fire.

Cooking

- _____ _____ a. Make three kinds of cooking utensils.
- _____ _____ b. Make a salad for a meal.
- _____ _____ c. Make a trail snack.

First Aid

- _____ _____ a. Make a poster of items that would go in a First Aid Kit.
- _____ _____ b. Make a personal First Aid Kit.
- _____ _____ c. Demonstrate how to make and use an ice pack.

Safety and Sanitation

- _____ _____ a. Discuss the use and abuse of drugs.
- _____ _____ b. Learn and explain the rules for riding a bicycle.
- _____ _____ c. Discuss and assemble a toiletry kit.

Map and Compass

- _____ _____ a. Explain which direction your house faces.
- _____ _____ b. Locate your house, church, and school on a map.
- _____ _____ c. Make a simple compass.

Nature Study

- _____ _____ a. Build an animal feeding station.
- _____ _____ b. Build an instrument to determine wind direction.
- _____ _____ c. Chart the weather forecast for two days.

Conservation

- _____ _____ a. Learn and explain the value of recycling.
- _____ _____ b. Collect tin cans, old clothing, or paper to be recycled.
- _____ _____ c. Plant a tree in your yard, at your church, or another appropriate place.

Fun and Worship

- _____ _____ a. Learn and recite the Lord's Prayer.
- _____ _____ b. Look in the hymnbook for three songs about nature and God.
- _____ _____ c. Read the 23rd Psalm.

_____ has completed the requirements for the Discoverer 3 patch.

Date Completed _____ Signed: _____ (Leader)

Hiker



Date Initials

Trip Planning

- _____ _____ a. Plan and carry out a combined one mile hike and cookout.
- _____ _____ b. Keep a log of this trip.
- _____ _____ c. Discuss what to do when lost.
- _____ _____ d. Afterwards, discuss the good and bad points of the hike.

Equipment and Shelter

- _____ _____ a. Show how to properly dress for a hike.

Rope Craft

- _____ _____ a. Demonstrate how to tie and use the overhand knot, square knot, and clove hitch.

Tool Craft

- _____ _____ a. Demonstrate how to open, close, pass, oil, and sharpen a pocket knife.
- _____ _____ b. Demonstrate the proper use of a knife.

Fire Craft

- _____ _____ a. Show the proper care and use of matches.
- _____ _____ b. Help prepare a good, safe place for an outdoor fire.
- _____ _____ c. Gather tinder, kindling, and fuel and light a basic fire. Keep it burning at least 3 minutes.
- _____ _____ d. Put out the fire properly and clean up the fire site.

Cooking

- _____ _____ a. Cook two items, such as toast and cocoa, or a one pot meal.

First Aid

- _____ _____ a. Demonstrate a simple, safe remedy for a burn, a cut, and a bruise.

Safety and Sanitation

- _____ _____ a. Show how to safely hike on the open road.
- _____ _____ b. Help make a simple latrine.
- _____ _____ c. Use good safety practices in all skills for Hiker.

Map and Compass

- _____ _____ a. Know the parts of a compass.
- _____ _____ b. Know how to set and sight a compass to designated objects.
- _____ _____ c. Be able to follow simple trail signs.

Nature

- _____ _____ a. Identify two harmful plants.
- _____ _____ b. Identify two harmful animals.

Conservation

- _____ _____ a. Learn the Conservation Pledge and show that you understand it.
- _____ _____ b. Demonstrate good conservation practices in all requirements.

Fun and Worship

- _____ _____ a. Learn a game or song that boys of other countries play or sing.
- _____ _____ b. Share a missionary story on a hike with your chapter.

_____ has completed the requirements for the Hiker patch.

Date Completed _____ Signed: _____ (Leader)

Camper



Date Initials

Trip Planning

- ____ ____ a. Participate in two one-day hikes or a one-night campout.
____ ____ b. Keep a log of one trip.
____ ____ c. Afterward, discuss this trip, telling the good and bad points.

Equipment and Shelter

- ____ ____ a. Show that you know how to select and pack the proper equipment for a one-night camp.
____ ____ b. Show that you know how to provide bedding suitable for locality.
____ ____ c. Help pitch a wall, pup, or other type of tent.

Rope Craft

- ____ ____ a. Demonstrate how to tie a joiner knot, a taut line hitch, a stopper knot, a loop knot, and an end-securing knot.
____ ____ b. Whip the ends of a rope.

Tool Craft

- ____ ____ a. Demonstrate the proper care and use of a bow saw.

Fire Craft

- ____ ____ a. Know and explain fire safety and control for your locality.
____ ____ b. Show that you can build two types of fires, such as crisscross, teepee, or charcoal fires. Know when they are used.
____ ____ c. Put out your fire properly and clean up the fire site.

Cooking

- ____ ____ a. Cook successfully using two different types of cooking—broiling, baking, or frying.
____ ____ b. Plan and cook a well-balanced meal using these same two types of cooking.

First Aid

- ____ ____ a. Help assemble or update a group First Aid Kit.

Safety and Sanitation

- ____ ____ a. Show that you know how to keep your cooking utensils clean in outdoor cooking.
____ ____ b. Demonstrate proper disposal of garbage.
____ ____ c. Help make a chapter latrine at camp.
____ ____ d. Use good safety practices in all skills for Camper.

Map and Compass

- ____ ____ a. Show that you know the length of your pace and how to use it in compass work.
____ ____ b. Show that you know how to follow a course with a compass.

Nature Study

- ____ ____ a. Identify two harmful insects.
____ ____ b. Identify two helpful insects.

Conservation

- ____ ____ a. Learn about, or visit, a private, state, or federal conservation project, such as a fish hatchery, tree farm, or game refuge.
____ ____ b. Tell why it is needed.

Fun and Worship

- ____ ____ a. Share a good hiking song about the outdoors.
____ ____ b. Learn and share a good missionary story which could be used around a camp fire.

_____ has completed the requirements for the Camper patch.

Date Completed _____ Signed: _____ (Leader)

Woodsman



Date Initials

Trip Planning

- _____ _____ a. Participate in two one-night campouts with your chapter.
- _____ _____ b. Keep a log of each trip.
- _____ _____ c. Afterwards, discuss the first trip, telling the good and bad points. Use this discussion to plan the second and other trips.

Equipment and Shelter

- _____ _____ a. Demonstrate how to select and properly pack your gear and equipment for an overnight campout.
- _____ _____ b. Show how to select and leave in good order a tent site.
- _____ _____ c. Pitch a tent.
- _____ _____ d. Make a piece of equipment for your own use, such as a ground cloth, survival kit, fishing kit, poncho, etc.
- _____ _____ e. Help make or repair some piece of group gear or equipment.

Rope Craft

- _____ _____ a. Demonstrate at least two types of lashing.
- _____ _____ b. Learn about three kinds of rope and properties of each.

Tool Craft

- _____ _____ a. Show that you know how to properly select, use and care for the tools necessary to carry out a one-night trip.
- _____ _____ b. Demonstrate proper selection, use, and care of any sheath knife.
- _____ _____ c. Make some kind of cooking device.

Fire Craft

- _____ _____ a. Build a trench fire.
- _____ _____ b. Put out your fire properly and clean up the fire site.

Cooking

- _____ _____ a. Plan and cook a well-balanced outdoor meal.

First Aid

- _____ _____ a. List items needed for a small personal first aid kit.
- _____ _____ b. Know what to do for treatment of contact with poison ivy.

Safety and Sanitation

- _____ _____ a. Show that you know how to build a simple latrine.
- _____ _____ b. Know what to do when lost in the woods.
- _____ _____ c. Identify two poisonous plants.
- _____ _____ d. Use good safety practices in all skills for Woodsman.

Map and Compass

- _____ _____ a. Show how to read and follow a map.
- _____ _____ b. Make a simple sketch of your campsite or other area.
- _____ _____ c. Show how to find directions by the stars.

Nature Study

- _____ _____ a. Read a book about nature and use it in making your collection.
- _____ _____ b. Make a nature collection and label each item.

Conservation

- _____ _____ a. Participate in a conservation project.
- _____ _____ b. Learn about the work of the state and federal conservation forestry services.

Fun and Worship

- _____ _____ a. Teach your group an outdoor game.
- _____ _____ b. Plan a ceremony or campfire activity using songs, stories, games, drama, or worship.

_____ has completed the requirements for the Woodsman patch.

Date Completed _____ Signed: _____ (Leader)

Pathfinder



Date Initials

Trip Planning

- _____ _____ a. Help plan and carry out a combined 5-mile hike and cookout with your group.
- _____ _____ b. Participate in two overnight campouts with your group.
- _____ _____ c. Discuss what to do when lost.
- _____ _____ d. Keep a personal journal of each camping trip.
- _____ _____ e. Following each activity, discuss the good points and those needing improvement and use this information in planning future trips.
- _____ _____ f. Schedule time alone during your campout to take a spiritual inventory of your life. Use the Spiritual Markers worksheet found in the appendix section to guide you during this quiet time with the Lord.
- _____ _____ g. Think of one mission project in which you would like to participate. How can you use your trip planning skills to accomplish this endeavor? Who are you going to recruit to help?

Equipment and Shelter

- _____ _____ a. Demonstrate how to properly dress for your hike.
- _____ _____ b. Demonstrate that you know how to select, pack and care for the proper gear and equipment for an overnight campout. Make a personal gear/equipment list.
- _____ _____ c. Demonstrate that you know how to provide bedding suitable for your locality.
- _____ _____ d. Demonstrate how to select and leave in good order a tent sight. Set up a tent.
- _____ _____ e. Make a piece of equipment for your own use. (ground cloth, survival kit, poncho, fishing kit)
- _____ _____ f. Help make or repair some piece of group gear or equipment.
- _____ _____ g. The Psalmist David said, "I would hurry to my shelter from the raging wind and the storm." (Psalm 55:8) What are some ways you can be spiritually equipped and prepared to face the storms of life?
- _____ _____ h. Think of some of the ways in which your knowledge of equipment and shelters can be used to share God's message to others. Share your thoughts and ideas with other Challengers and your leader.

Rope Craft

- _____ _____ a. Whip the ends of a rope.
- _____ _____ b. Demonstrate how to tie and use the overhand knot, square knot, and clove hitch.
- _____ _____ c. Demonstrate how to tie and use a joiner knot, a stopper knot, a loop knot, an end securing knot and a taut line hitch.
- _____ _____ d. Demonstrate at least two types of lashing.
- _____ _____ e. Learn about three different kinds of rope and the properties of each.
- _____ _____ f. In 1793, as William Carey, who is considered as the Father of the Modern Mission Movement, was making preparations to board a ship to India, he used the analogy that he felt he was being lowered into a dark well by a rope. He was not afraid as long as he knew that his faithful friend Andrew Fuller would hold onto the rope by praying and giving to support to the mission work. This is not a task that can be accomplished alone. Will you remain faithful and hold onto the rope of missionaries by praying for and giving to missions? Have you ever sensed that God has been calling you to tie the rope around yourself and be on mission with Him? Pray and ask God to reveal to you how you are to respond to His invitation to join Him in accomplishing His mission.
- _____ _____ g. Learn ways in which rope craft can be used to share God's message of salvation with others. Your leader can assist you with this endeavor.

Tool Craft

- ___ ___ a. Demonstrate how to properly open, close, pass, oil and sharpen and use a folding or pocket knife.
- ___ ___ b. Demonstrate the proper care and use of a bow saw.
- ___ ___ c. Demonstrate that you know how to properly select and use tools necessary for an overnight trip.
- ___ ___ d. Demonstrate the proper use and care for a sheath knife.
- ___ ___ e. Make some kind of cooking device.
- ___ ___ f. A knife can be both a tool and a weapon. What makes the difference? It depends upon who is holding the knife. How can your life be used by God as a tool to accomplish His mission? Record your thoughts and share with your leader.
- ___ ___ g. How can your knowledge of tools assist you in accomplishing God's purpose in your life? Ask God to reveal to you His purpose for your life and what type of instrument you can be in His hands.

Fire Craft

- ___ ___ a. Know and explain fire safety and control for your locality.
- ___ ___ b. What three things must be present for fire? The Fire Triangle.
- ___ ___ c. Demonstrate proper care of matches.
- ___ ___ d. Help prepare a good, safe place for an outdoor fire.
- ___ ___ e. Gather tinder, kindling, and fuel and light a basic fire. Keep it burning for at least 3 minutes.
- ___ ___ f. Demonstrate two types of fires such as crisscross, teepee, or trench, and their use.
- ___ ___ g. Choose and prepare a fire site for an alternate type of fire such as charcoal, canned heat or stoves. Demonstrate how to light, use, and extinguish the type of fire selected and the reasons for using alternate methods.
- ___ ___ h. Demonstrate how to use a camp stove properly.
- ___ ___ i. Put out your fire properly and clean up fire site.
- ___ ___ j. Read Hebrews Chapter 12. Why do you believe that God is described as a "consuming fire"? Who are the "great cloud of witnesses"? Are there individuals you can identify as a modern "great cloud of witnesses"? "Remember your leaders who have spoken God's word to you. As you carefully observe the outcome of their lives, imitate their faith." Hebrews 13:7
- ___ ___ k. Jesus encouraged His disciples to "let your light shine before men, that they may see your good deeds and praise your Father in heaven." (Matthew 5:16) How can you let your light shine for the glory of the Father?

Cooking

- ___ ___ a. Plan and cook a complete meal outdoors for yourself.
- ___ ___ b. Cook successfully for your group using two different types of outdoor cooking. (Broiling, baking, frying, reflector.)
- ___ ___ c. Read 2 Peter 1:5-9. What are the ingredients needed in the recipe for a Christian life? How much of the ingredient is needed and what is the outcome?
- ___ ___ d. Living the Christian life involves a personal relationship with the Father. Look over the attributes listed in 2 Peter 1:5-9 again and ask God to show you the areas of your life that need an increased measure in order that you may be effective and productive in your knowledge.

First Aid

- _____ a. List and assemble the items needed for a personal first-aid kit.
- _____ b. Help assemble or update a group first-aid kit.
- _____ c. Demonstrate a simple, safe remedy for a burn, a cut, a bruise, and an insect bite.
- _____ d. Know what to do for treatment of contact with poison ivy or other poisonous plants.
- _____ e. Read the parable of the good Samaritan that is recorded in Luke 10:30-37. Discuss your thought with your pastor or another godly man in your church. Did you know that Luke was a physician (doctor) in his time?
- _____ f. Select a missions project which will allow you to use some of your first aid skills. Work with other professionals as they render first aid and watch as they meet others needs.

Safety and Sanitation

- _____ a. Demonstrate how to hike on the open road and in a wilderness area.
- _____ b. Demonstrate a simple latrine.
- _____ c. Help make a group latrine at camp.
- _____ d. Demonstrate proper disposal of garbage on a hike or campout.
- _____ e. Demonstrate that you know how to keep your cooking and eating utensils clean in outdoor cooking.
- _____ f. Use good safety and sanitation practices in all skills for Pathfinder.
- _____ g. Read Deuteronomy 23:12-14. Who commanded this Safety and Sanitation commandment?
- _____ h. Taking care of your basic human needs and your safety is important. Find another Biblical example of the importance of maintaining proper safety and sanitation procedures. If you would like assistance, ask a godly man to assist you in this endeavor. How does the passage that you selected apply to your life?

Map and Compass

- _____ a. Know the parts of a compass.
- _____ b. Know how to set and sight a compass to designated objects.
- _____ c. Be able to follow simple trail signs.
- _____ d. Demonstrate that you know the length of your pace and be able to use it in compass work.
- _____ e. Demonstrate that you know how to follow a course with a compass.
- _____ f. Demonstrate how to read and follow a map.
- _____ g. Make a simple sketch of your campsite or other area.
- _____ h. Demonstrate how to find directions by the stars.
- _____ i. Read Psalms 8:3-4. What do you think were David's thoughts concerning the stars and his relationship with the created universe?
- _____ j. What are your thoughts about your place in the created universe? How does this knowledge impact your life?

Nature

- _____ a. Identify two harmful and helpful insects while on your campout.
- _____ b. Identify two harmful plants and harmful animals in your camp area.
- _____ c. Read a book about nature and use it in making a collection, labeling each item.
- _____ d. Read Psalm 8. Record your reflections and ask God to show you himself in nature. Share your insights with others.
- _____ e. How can your knowledge of the created order assist you in making an impact in the world?

Conservation

- _____ a. Learn the Conservation Pledge and show that you understand the pledge.
- _____ b. Demonstrate good conservation practices in all requirements.
- _____ c. Learn about or visit a private, state, or federal conservation agency or project. Tell why it is needed.
- _____ d. Select and carry out a personal conservation project.
- _____ e. Read the parable of testing of servants recorded in Luke 12:41-48. What reflections do you have and how should you respond?
- _____ f. How can you use your knowledge of conservation practices in a missions project?

Fun and Worship

- _____ a. Learn a game or song that boys from other countries play or sing.
- _____ b. Share a missionary story or personal testimony around the campfire.
- _____ c. Plan a ceremony or campfire activity using songs, stories, games, drama, or worship.
- _____ d. Spend time outdoors, remaining quiet and meditating upon the wonders that God has created. Praise Him for who He is and all that He has created in addition to the love relationship that He has called you to maintain.
- _____ e. Share with another Challenger or your leader why worship is an important aspect of the Christian life.

_____ has completed the requirements for the Pathfinder patch.

Date Completed _____ Signed: _____(Leader)

Date Initials

Adventurer



Trip Planning

- ___ ___ a. Participate in two, two-night campouts using all the Adventurer skills below.
- ___ ___ b. Help make plans with others including complete meals, equipment, and assignments.
- ___ ___ c. Keep a personal journal of each camping trip.
- ___ ___ d. Discuss the good points and those needing improvements and use this information in planning future trips.
- ___ ___ e. Record a spiritual application in your journal that has been revealed to you on your trip.
- ___ ___ f. Work together with your Challenger group and use the skills of trip planning to organize a missions project and record what you accomplished in a journal.

Equipment and Shelter

- ___ ___ a. Demonstrate proper selection and packing of clothing and personal gear for a two-night trip.
- ___ ___ b. Demonstrate that you can prepare more than one type of shelter for yourself.
- ___ ___ c. List and help assemble the group equipment and gear needed for a two-night campout.
- ___ ___ d. Spiritual Application: In Isaiah 25:4, the Lord is praised for one of His attributes: "You have been a refuge for the poor, a refuge for the needy in distress, a shelter from the storm and a shade from the heat." What piece of equipment could be used to describe an attribute of God?
- ___ ___ e. Use your knowledge of temporary shelters to construct a shelter for someone in need.

Rope Craft

- ___ ___ a. Make a semipermanent camp fixture using knots and lashings.
- ___ ___ b. Demonstrate that you can tie two knots that you have not tied before.
- ___ ___ c. How can rope craft point others to Christ?
- ___ ___ d. Identify three ways you can use your knowledge of rope craft to help others.

Tool Craft

- ___ ___ a. Demonstrate that you know how to select, sharpen, care for, and use of an axe.
- ___ ___ b. Demonstrate proper selection, use and care of other camping tools.
- ___ ___ c. Read 2 Kings 6:1-6. How could this story affect your life?
- ___ ___ d. Demonstrate your knowledge of tool craft by utilizing tools to minister to others.

Fire Craft

- ___ ___ a. Build a campfire for your group and light it successfully. Use a type of fire or fire site that you have not previously demonstrated.
- ___ ___ b. Demonstrate that you know how to find and protect fuels in bad weather.
- ___ ___ c. Demonstrate that you can build a fire with damp wood or keep a fire burning in the rain.
- ___ ___ d. Put out fires properly and clean up your fire site.
- ___ ___ e. Demonstrate how to light, use, and care for several different types of camp lanterns or other light sources.
- ___ ___ f. Fire is often used as a sign of purity. Discuss with your church pastor some Biblical examples which use fire to represent spiritual purity.
- ___ ___ g. Construct several different types of emergency lighting that can be used during a power outage and work with your church in identify possible locations for storage.

Cooking

- ___ ___ a. Cook successfully using two types of cooking you have not demonstrated before, such as reflector baking, aluminum foil, Dutch oven, etc.
- ___ ___ b. Help plan and pack three complete meals for a trip.
- ___ ___ c. Demonstrate how to light, use, and care for several different camp stoves.
- ___ ___ d. Jesus used the term "bread of life." Discuss this concept with a leader.
- ___ ___ e. Use you culinary skills to prepare a meal outdoors and minister to someone who is home bound.

First Aid

- ___ ___ a. Demonstrate that you know how to treat sprains, heat exhaustion, heat stroke, and hypothermia.
- ___ ___ b. Review and update your personal first aid kit.
- ___ ___ c. Jeremiah 8:22 speaks of the balm in Gilead, a type of first-aid ointment. What type of problem existed that needed treatment? Discuss your thoughts with your leader.
- ___ ___ d. Choose a mission project that will allow you to use some of the first aid knowledge that you have acquired.

Safety and Sanitation

- ___ ___ a. Make a simple waste water pit or use another proper disposal method.
- ___ ___ b. Demonstrate proper food storage for duration of camping trip.
- ___ ___ c. Use good safety practices in all skills for Adventurer.
- ___ ___ d. Create a spiritual application related to safety and sanitation and share it with your leader. Ask your leader to share one with you.
- ___ ___ e. Choose a mission project that relates to Safety and Sanitation and work towards meeting other's needs.

Map and Compass

- ___ ___ a. Go cross-country with a map and compass for at least a mile, following your leader's instructions.
- ___ ___ b. Map the area traveled by a sketch map.
- ___ ___ c. Be able to find directions by the sun.
- ___ ___ d. Jesus Christ is known as the Way, the Truth and the Life. Think of one way in which your map and compass can illustrate leading others to Christ. Share this spiritual application with a friend.
- ___ ___ e. Look for ways in which you can point others to Christ. Ask your leader to pray with you to discover someone who is in spiritual darkness that is in need of guidance.

Nature

- ___ ___ a. Make a new nature collection using a new book.
- ___ ___ b. Identify five trees or plants in the field.
- ___ ___ c. Identify five animals or insects in the field.
- ___ ___ d. Read Job 38 and record your impressions below. Give thanks to God for who He is and what He has done.
- ___ ___ e. Identify several ways that Christ used nature to witness to others about God. Think of one spiritual application using nature you can use to witness to others.

Conservation

- ___ ___ a. Carry out a conservation project with your group.
- ___ ___ b. Share with someone a spiritual application which relates to conservation.
- ___ ___ c. How can you use your knowledge of conservation practices to assist in a mission project?

Fun and Worship

- ___ ___ a. Plan and conduct camp fun activities that are not normally done at home or school.
- ___ ___ b. Plan and conduct a camp worship experiences.
- ___ ___ c. Reflect upon worship. Recall a time when you have drawn near to the Father in a worshipful spirit and the experience you encountered. Pray that God will direct your future times of worship to become meaningful and productive times for you.
- ___ ___ d. Ask God to reveal to you how you can use Fun and Worship as a way to convey spiritual truths to others.

_____ has completed the requirements for the Adventurer patch.

Date Completed_____ Signed:_____ (Leader)

Date Initials

Backpacker



Trip Planning

- _____ _____ a. Help plan and carry out a three-day, two-night backpacking trip (each night at a different location), demonstrating all the Backpacker skills below.
- _____ _____ b. After the trip, discuss the good points and those needing improvement with the group and use this information to assist in planning future trips.
- _____ _____ c. Share a spiritual application with your leader or your group.
- _____ _____ d. Participate in a mission project or share a missions application.

Equipment and Shelter

- _____ _____ a. Make a personal equipment and clothing list for your three day backpacking trip. Use the list as you select and pack for the trip.
- _____ _____ b. Demonstrate that you know how to properly select, pack, and care for your equipment for a three-day backpacking trip. Know the maximum poundage you can carry.
- _____ _____ c. Learn how to make a temporary shelter using a ground cloth or poncho.
- _____ _____ d. Demonstrate proper selection of clothing to take on your backpacking trip.
- _____ _____ e. Share a spiritual application with your leader or your group.
- _____ _____ f. Participate in a mission project or share a missions application.

Rope Craft

- _____ _____ a. Demonstrate the use of at least four knots useful in backpacking.
- _____ _____ b. Share a spiritual application with your leader or your group.
- _____ _____ c. Participate in a mission project or share a missions application.

Tool Craft

- _____ _____ a. Demonstrate that you know how to properly select, pack, and use safely the tools necessary for your backpacking trip.
- _____ _____ b. Share a spiritual application with your leader or your group.
- _____ _____ c. Participate in a mission project or share a missions application.

Fire Craft

- _____ _____ a. Be aware of fire regulations for the backpacking area you selected. Consult with the local officials concerning the fire regulations.
- _____ _____ b. Demonstrate that you can build and keep a fire burning under wet conditions. Discuss special heat needs for dry, windy, or snowy conditions. Consider when a fire is neither advisable nor desirable.
- _____ _____ c. Share a spiritual application with your leader or your group.
- _____ _____ d. Participate in a mission project or share a missions application.

Cooking

- _____ _____ a. Assist in the planning, packaging, and preparation of meals for your three-day backpacking trip that includes the use of dehydrated and/or freeze dried foods.
- _____ _____ b. Demonstrate on your backpacking trip new methods of cooking or style of menu preparation.
- _____ _____ c. Demonstrate proper use of backpacking stoves.
- _____ _____ d. Share a spiritual application with your leader or your group.
- _____ _____ e. Participate in a mission project or share a missions application.

First Aid

- _____ a. Have a current accreditation in the Red Cross Standard First-Aid course or an equivalent.
- _____ b. Discuss first-aid care for the most common injuries that might occur on your backpacking trip.
- _____ c. Discuss the contents of the group and personal first-aid kits for your backpacking trip.
- _____ d. Share a spiritual application with your leader or your group.
- _____ e. Participate in a mission project or share a missions application.

Safety and Sanitation

- _____ a. Discuss your trip plans and list precautions to be taken. File a travel plan with someone prior to departure. Include emergency evacuation procedures.
- _____ b. Develop personal health guides in regard to food, sleep, rest, exercise, and cleanliness.
- _____ c. Demonstrate several methods of water purification.
- _____ d. Demonstrate proper methods of sanitation on your backpacking trip.
- _____ e. Share a spiritual application with your leader or your group.
- _____ f. Participate in a mission project or share a missions application.

Map and Compass

- _____ a. Demonstrate that you know how to read and use a topographical map.
- _____ b. Demonstrate the use of map and compass skills on your backpacking trip.
- _____ c. Demonstrate your ability to use triangulation skills with a map and compass to locate a place, object, or designated point on a map.
- _____ d. Share a spiritual application with your leader or your group.
- _____ e. Participate in a mission project or share a missions application.

Nature

- _____ a. Identify three wild animals common to the area of your backpacking trip and the game laws that may apply to them.
- _____ b. Learn and discuss with your Challenger group clouds, wind, and other natural forces that are indicators of weather conditions.
- _____ c. Share a spiritual application with your leader or your group.
- _____ d. Participate in a mission project or share a missions application.

Conservation

- _____ a. Practice using minimum impact methods on your backpacking trip.
- _____ b. Demonstrate good conservation and safety techniques in the selection of campsites and the use of natural materials while on a backpacking trip.
- _____ c. List and discuss examples of good and bad conservation practices that you observed on a backpacking trip.
- _____ d. Share a spiritual application with your leader or your group.
- _____ e. Participate in a mission project or share a missions application.

Fun and Worship

- _____ a. Give a devotional thought, message, or testimony during your backpacking trip.
- _____ b. Learn and play a game that does not require any special equipment that can be used on a backpacking trip.
- _____ c. Share a spiritual application with your leader or your group.
- _____ d. Participate in a mission project or share a missions application.

_____ has completed the requirements for the Backpacker patch.

Date Completed_____ Signed:_____ (Leader)

Date Initials

Trip Camper



Trip Planning

- a. Go on a trip lasting at least four days and camp at three or more different sites using all of the skills below. This trip can utilize any mode of transportation.
- b. Share responsibility with others in the group for plotting the route, selecting camp sites, planning transportation, making personal and group equipment lists, preparing menus, duty charts, and activities to be enjoyed on the trip.
- c. Plan and participate in pre-trip physical conditioning.
- d. Help set up a temporary camp quickly.
- e. Keep a journal of your camping experience and evaluate the trip with your group.
- f. Share a spiritual application with your leader or your group.
- g. Participate in a mission project or share a missions application.

Equipment and Shelter

- a. Apply waterproofing treatment to cloth and use it to make a knapsack, duffel bag, ground cloth, sleeping bag, or pack.
- b. Research information on four types of tents (a rain fly will serve as one type) and know their advantages and disadvantages. Decide which style would be most useful for your section of the country and the type of camping you want to do.
- c. Demonstrate your ability to pack for the type of transportation chosen for your camping trip, such as car, pack animal, bike or canoe, etc.
- d. Be able to repair and care for the transportation you will use on your camping trip, such as pack, shoes, saddle, canoe, bike, car, etc.
- e. If possible, work with another group in your community to assist them in assembling a basic set of camping equipment.
- f. Share a spiritual application with your leader or your group.
- g. Participate in a mission project or share a missions application.

Rope Craft

- a. Demonstrate two methods of splicing a rope. Discuss the reasons for splicing.
- b. Be able to coil and throw a rope.
- c. Demonstrate how to tie and use a joiner knot, a stopper knot, a loop knot, and an end-securing knot. These should be knots not previously learned.
- d. Share a spiritual application with your leader or your group.
- e. Participate in a mission project or share a missions application.

Tool Craft

- a. List the appropriate tools necessary for your trip. Demonstrate your ability to use and maintain these tools.
- b. Determine the way you will store the tools on your trip.
- c. Share a spiritual application with your leader or your group.
- d. Participate in a mission project or share a missions application.

Fire Craft

- a. Increase your skill in fire building by reviewing the different types of outdoor fires previously learned.
- b. Discuss the use of emergency fires and fuels.
- c. Review fire safety procedures for three different terrains, i.e., grasslands, swamp, mountains, and forest.
- d. Share a spiritual application with your leader or your group.
- e. Participate in a mission project or share a missions application.

Cooking

- a. Plan complete, economical menus and equipment needed for your four-day trip.
- b. Prepare recipes and a shopping list for the meals on your trip. Consider the weather, storage, transportation (space and weight), and preparation methods.
- c. Practice preparing various foods prior to your trip.
- d. Assist in shopping for the foods to take on your trip.
- e. Share a spiritual application with your leader or your group.
- f. Participate in a mission project or share a missions application.

First Aid

- a. Have a current accreditation in the Red Cross Standard First Aid course or an equivalent.
- b. Discuss first aid care for the most common injuries that might occur on your trip.
- c. Discuss the contents of the group and personal first aid kits for your trip.
- d. Share a spiritual application with your leader or your group.
- e. Participate in a mission project or share a missions application.

Safety and Sanitation

- a. Know and discuss with your group, the health and safety rules/practices for the particular type of trip camping chosen.
- b. Know the "rules of the road" for hikers, cars, canoes, boats, bicycles, etc.
- c. Discuss trip plans and list precautions to be taken. File a travel plan with someone prior to departure, including emergency evacuation procedures.
- d. Know what to do in cause you get lost.
- e. Agree with your group, rules about personal health for use before, during, and after a trip. As a group, agree upon the rules.
- f. Make a list of the resources for taking care of groups in emergencies where you are going on your trip. Resources include: Persons, departments, organizations, medical facilities, and publications.
- g. Share a spiritual application with your leader or your group.
- h. Participate in a mission project or share a missions application.

Map and Compass

- a. Demonstrate your ability to judge the following: time, distance, and height.
- b. Demonstrate your ability to use a compass, map, or chart in an emergency to locate a place, object, or designated point on a map.
- c. Using a map and compass, plot your route for at least three miles. Submit a sketch map of the trip that would enable another person to follow your route.
- d. Familiarize yourself with a road map, a topographical map, and a waterway chart. Explain latitude and longitude.
- e. Share a spiritual application with your leader or your group.
- f. Participate in a mission project or share a missions application.

Nature

- a. Demonstrate your new knowledge of trees by being able to identify at least ten trees by their buds, leaves, flowers, cones, bark, or silhouettes. Be able to identify these trees in their natural setting during any season of the year.
- b. Identify five constellations and be able to identify the North Star.
- c. Make or improve a nature trail for your church, association, or state campsite.
- d. Know several simple gadgets for determining weather forecasts and know how to read a weather map.
- e. Make weather forecasts before and during your trip.
- f. Keep a weather log of the trip you take.
- g. Share a spiritual application with your leader or your group.
- h. Participate in a mission project or share a missions application.

Conservation

- a. Prepare a list of camping spots for overnight or longer. Indicate facilities for cooking, programs, safety, distance from town, permission needed, and interesting points about each site.
- b. Participate in a project to improve one of these sites.
- c. Share a spiritual application with your leader or your group.
- d. Participate in a mission project or share a missions application.

Fun and Worship

- a. Prepare a schedule of fun and worship sessions for your trip. Assign different activities to members of your group.
- b. Share a spiritual application with your leader or your group.
- c. Participate in a mission project or share a missions application.

_____ has completed the requirements for the Trip Camper patch.

Primitive Camper



Date Initials

Trip Planning

- _____ _____ a. Go on a primitive camp of four or more days.
- _____ _____ b. Actively help in selecting and setting up the base campsite.
- _____ _____ c. Plan with your group transportation, equipment list, prepare menus and duty charts, and decide on activities at camp.
- _____ _____ d. Keep a journal of your primitive camping trip and evaluate the trip with your group.
- _____ _____ e. Share a spiritual application with your leader or your group.
- _____ _____ f. Participate in a mission project or share a missions application.

Equipment and Shelter

- _____ _____ a. Know types of clothing suitable for primitive camping. Prepare a personal checklist that can be used when packing your equipment for camp.
- _____ _____ b. Make, pack, and carry a bed roll.
- _____ _____ c. Demonstrate that you can construct and take down a primitive shelter using natural materials.
- _____ _____ d. Share a spiritual application with your leader or your group.
- _____ _____ e. Participate in a mission project or share a missions application.

Rope Craft

- _____ _____ a. Name several uses for ropes.
- _____ _____ b. Be able to tie the following knots: square, clove hitch, half hitch, sheet bend, sheep shank, and bowline.
- _____ _____ c. Demonstrate the above knots in the camp setting.
- _____ _____ d. Demonstrate four types of lashing and use them in constructing a comfortable campsite.
- _____ _____ e. Share a spiritual application with your leader or your group.
- _____ _____ f. Participate in a mission project or share a missions application.

Tool Craft

- _____ _____ a. Properly use a pocketknife to make shavings, and an axe to chop and split wood into kindling.
- _____ _____ b. List tools needed for a primitive camp.
- _____ _____ c. Know how to sharpen, pack, carry, care for, and store tools. Explain safety rules for each tool.
- _____ _____ d. Make something useful with one or more of your tools.
- _____ _____ e. Make two articles such as a tin can stove, buddy burner, individual reflector oven, or charcoal stove, from tin cans, using appropriate tools. Use these articles in your primitive camp.
- _____ _____ f. Share a spiritual application with your leader or your group.
- _____ _____ g. Participate in a mission project or share a missions application.

Fire Craft

- _____ _____ a. Know fire regulations of the locale and time of your primitive camp. Demonstrate all fire safety rules.
- _____ _____ b. Gather tender, kindling, and fuel and be able to start a fire outdoors quickly and easily in all types of weather. Build it into a fire suitable for boiling, broiling, or baking.
- _____ _____ c. Demonstrate methods for making lighting: oil lamps, candles, torches, etc. Use one of these as your light source in your primitive camp.
- _____ _____ d. Share a spiritual application with your leader or your group.
- _____ _____ e. Participate in a mission project or share a missions application.

Cooking

- _____ _____ a. Plan complete, economical menus for your primitive camp. Prepare recipes, grocery shopping list, and equipment needed.
- _____ _____ b. Cook successfully by each of the following methods: one pot, skillet, toasting-broiling and baking. Cook at least one thing by each of the following methods: ember cooking, reflector cooking, and planking.
- _____ _____ c. In a primitive camp eat at least one meal consisting of one or more items off the land including meat or fish. Be sure to observe hunting and fishing regulations.
- _____ _____ d. Share a spiritual application with your leader or your group.
- _____ _____ e. Participate in a mission project or share a missions application.

First Aid

- _____ a. Have a current accreditation in the Red Cross Standard First Aid Course or an equivalent.
- _____ b. Discuss first aid care for the most common injuries that might occur on your primitive campout.
- _____ c. Discuss and assemble a primitive first aid kit that will meet your camping needs. Know how to use each item in the kit.
- _____ d. Share a spiritual application with your leader or your group.
- _____ e. Participate in a mission project or share a missions application.

Safety and Sanitation

- _____ a. Be familiar with several methods of water purification and demonstrate one.
- _____ b. Know several safe methods of outdoor dishwashing and use one for your group.
- _____ c. Build, maintain, and use a group latrine during the primitive campout.
- _____ d. Use proper methods to dispose of waste and garbage.
- _____ e. Share a spiritual application with your leader or your group.
- _____ f. Participate in a mission project or share a missions application.

Map and Compass

- _____ a. Explain the use of a compass and such words as declination and orientation.
- _____ b. Draw a sketch, using a compass and conventional map symbols, of your group campsite or prepare the sketch of a trail for a hike in the vicinity.
- _____ c. Share a spiritual application with your leader or your group.
- _____ d. Participate in a mission project or share a missions application.

Nature

- _____ a. Identify ten trees common to your area and know their use to campers (fire building, crafts, or construction).
- _____ b. Be able to recognize poisonous plants, insects and snakes found in your camping area and know the precautions to take.
- _____ c. Know at least four weather signs for forecasting the weather.
- _____ d. Recognize cloud formations and be able to tell their meanings.
- _____ e. Know which prevailing winds indicate fair and stormy weather.
- _____ f. Share a spiritual application with your leader or your group.
- _____ g. Participate in a mission project or share a missions application.

Conservation

- _____ a. Practice conservation in all outdoor activities.
- _____ b. Know the common causes of forest fires, what can be done to prevent them, and the methods of fighting fires.
- _____ c. Prepare a list and discuss the effects on the ecology caused by improper conservation practices in a wilderness camp.
- _____ d. Share a spiritual application with your leader or your group.
- _____ e. Participate in a mission project or share a missions application.

Fun and Worship

- _____ a. Explain how recreation contributes to physical fitness and mental well-being.
- _____ b. Discuss the need for and plan personal quiet times and devotion/worship times during the primitive camp.
- _____ c. Share a spiritual application with your leader or your group.
- _____ d. Participate in a mission project or share a missions application.

_____ has completed the requirements for the Primitive Camper patch.

Date Completed _____ Signed: _____ (Leader)

Spiritual Markers

This worksheet is designed to assist a Challenger in evaluating his life and relationship with Jesus Christ and encourage the Challenger to make any necessary adjustments in order to accomplish the purpose that God has for their life. In order to accomplish this spiritual examination you will need at least 30 minutes, a Bible, a pencil or pen and paper, a prayerful attitude, and a comfortable quite place.

A Word from the Word: Carefully read Psalm 139 and answer the following questions.

- Who searches and knows everything about me? (Verses 1-4) _____
- Where can I go to escape God's presence? (Verses 7-12) _____
- When did God first know everything about me? (Verses 13-16) _____
- How many times does God think about me? (Verses 17-18) _____
- Read verses 23 and 24 again. Make them your prayer for this time of spiritual inspection.

Getting Specific: Do you want God to search you? Are there any offensive (harmful) ways in you? That last question is hard to answer without evaluating specific areas of your life, so let's get specific. Are you ready? Just answer yes or no to the following questions.

- | | |
|---|---|
| _____ Do I really love Jesus? | _____ Do I look for opportunities to encourage others? |
| _____ Do I know that He really loves me? | _____ Do I obey governmental laws? |
| _____ Do I know I will live forever with God? | _____ Do I take care of my body (God's temple)? |
| _____ Do I have pure thoughts and motives? | _____ Do I engage in healthy habits? |
| _____ Do I find joy in my Christian Life? | _____ Do I exhibit self-control? |
| _____ Do I experience God's peace? | _____ Do I use crude language? |
| _____ Do I spend time in God's Word daily? | _____ Do I look at or read improper materials? |
| _____ Do I find time to talk with God in prayer? | _____ Do I watch questionable videotapes, movies TV or questionable Internet sites? |
| _____ Do I attend weekly Bible studies? | _____ Do I seek to do my best even when no one is around? |
| _____ Do I exhibit Christ's love? | _____ Do I harbor any bitterness or hate toward someone? |
| _____ Do I find ways to serve needy people? | _____ Do I act as a responsible steward of God's earth? |
| _____ Do I obey God as He reveals His will to me through His Word? | _____ Do I look to Christ as the model for my life? |
| _____ Do I worship God weekly with other Christians? | _____ Do I treat all people as Christ would want me to treat them? |
| _____ Do I actively support missions and ministry through church offerings? | _____ Do I respond with sensitivity to the needs of others at school, home, and various other places? |
| _____ Do I seek opportunities to lead non-Christian friends to Christ? | |

Being Real: Now read Hebrews 4:13. Is there anything you can hide from God's sight? _____

Review your responses to the previous questions. What do they suggest about your relationship with God? _____

Would you feel confident if you had to give God an account of your life today? _____

Are there any areas of your life that need adjusting? _____

Read Psalm 139: 23-24 again. Has God's Spirit revealed any thoughts, attitudes or actions with which you need to deal? _____

John 16:8 tells us that the Holy Spirit will convict us of guilt in regard to sin, righteousness and judgment. If God has convicted you of specific areas in your life that are opposed to His will, you will need to seek His forgiveness.

When we sin, our fellowship with God is broken. The burden of guilt is often overbearing. When we confess our sins and accept God's forgiveness, our fellowship with God is restored. Read 1 John 1:8-10, now re-write verse 9: _____

Do you desire to experience His forgiveness and cleansing? _____. If so, be honest and specific with your sin. Make a list on a sheet of paper. Once you complete your list of all known sins, confess your sins one by one. As you confess each one mark it out, accept God's forgiveness, and offer God thanks. Trust God and His ability to make you pure and righteous in Christ.

A Letter to Your Heavenly Father: Take time to write a sincere and thoughtful letter of response to God's love and forgiveness on the back of the paper with the list of sins.

Personal Worship: The Bible instructs us to enter His gates with thanksgiving and His court with praise; give thanks to Him and praise His name (Psalm 104:4). In response to God's love and forgiveness, it is appropriate to take time to follow the instruction of this verse.

Enter His Gates With Thanksgiving: Thank God for what He has done. Be specific in your appreciation. With a prayerful attitude, read the following passages from your Bible. Personalize each verse by inserting your name where appropriate. The following is an example to follow:

For God so loved (your name) that He gave His one and only Son, that (as your name) believes in Him shall not perish but have eternal life. (John 3:16)

Now find and underline each verse in your Bible. Then say a prayer of thanksgiving. Here's an example of a prayer of thanksgiving: "Father, thank You for loving me and giving me eternal life." Follow this pattern for each of the references below.

John 10:27-28
John 14:21,23

Romans 8:35-39
Philippians 4:13,19

Now think about a song, hymn or chorus that offers thanksgiving to God and silently recite the words.

Enter His Courts With Praise: Praise God for who He is. Think of several different names of God – Father, Jesus, Holy Spirit, Creator, Bread of Life, Comforter – and praise Him for His awesome character and majesty. Read the following passages that reveal other characteristics about God. After you read each verse in your Bible, underline the name, title or description given for God, then praise God for His nature. The first reference is completed as an example for you to follow.

When Abram was ninety-nine years old, the Lord appeared to him and said, "I am God Almighty walk before me and be blameless. (Genesis 17:1)

Your response: "Father, I praise you for being my Lord, and my God Almighty!"

Isaiah 9:6
Revelation 1:17-18
John 14:6

John 10:11
John 6:35

Indeed, God is faithful to love us even when we are not faithful. As you continue in your walk with Christ, submit yourself to His authority and obey His Word. As you do, your journey will be an exciting one and God will use you for His glory.

Final Thoughts: Before joining the others, look over your Spiritual Markers worksheet again. Respond to the following questions, and read 1 Corinthians 15:58.

What one thought do you desire to remember from this experience?

What one thing does God want you to do in response to this time with Him?

"Therefore my dear brothers, stand firm. Let nothing move you. Always give yourselves fully to the work of the Lord, because you know that your labor in the Lord is not in vain." (1 Corinthians 15:58)

Pledge to the American Flag

I Pledge Allegiance to
the flag of the United
States of America and to
the Republic for which it
stands, one Nation
under God, indivisible,
with liberty and justice
for all.

Pledge to the
Christian Flag

I pledge allegiance to
the Christian flag, and to
the Savior for whose
kingdom it stands, one
brotherhood uniting all
Christians in service
and love.

Pledge to the Bible

I pledge allegiance to the Bible, God's Holy Word, and will make it a lamp unto my feet, a light unto my path, and hide its words in my heart that I may not sin against God.

As a Royal Ambassador I will do my best:

To become a well-informed, responsible follower of Christ;

To have a Christlike concern for all people;

To learn how to carry the message of Christ around the world;

To work with others in sharing Christ; and

To keep myself clean and healthy in mind and body.

Challenger Verse

“Therefore, my dear brothers, stand firm. Let nothing move you. Always give yourself fully to the work of the Lord, because you know that your labor in the Lord is not in vain.”

(1 Corinthians 15:58)

Conservation *Pledge*

I give my pledge as an American to save and faithfully to defend from waste the natural resources of my country - its air, soil, and minerals, its forests, waters, and wildlife.

Camper's Travel & Medical Release Form

Parent's Authorization:

I hereby give my permission for _____, to accompany _____
on a trip to _____ during these dates: _____

I understand that our family insurance is the primary insurance. My signature below will authorize any emergency medical or surgical treatment, as needed for my child by a physician chosen by the leader or another adult that is in charge.

Please list any medications or drugs that may cause an allergic reaction: _____

Please list any previous medical problems or illnesses: _____

List any prescriptions and directions that are currently being taken:

Prescription: _____ Directions: _____

Prescription: _____ Directions: _____

Current status of immunizations: (Please attach a copy of their shot records)

Approximate date of last tetanus shot: _____

Name of Family Doctor: _____ Phone: _____

Address: _____

Parents' Home Phone: _____ Work Phone: _____

List another adult to contact in an emergency:

Name: _____ Phone: _____

Parent's Signature

Date

Insurance Company: _____ Policy #: _____

Address: _____ Phone: _____

Signed before me this day _____ (date) _____

(Notary's signature and seal)

Scripture References

Introduction

Genesis 4:20	Jabal is declared the father of such who dwell in tents.
Genesis 25:27	Jacob was said to be a plain man dwelling in tents.
Judges 7:1-8	Gideon was instructed by the Lord to reduce his army.
1 Samuel 20:36	Jonathan used a boy to bring back the arrows that he shot.
1 Kings 5:9	Hiram, the king of Tyre made rafts and floated them on the sea.
1 Kings 19:5-8	Elijah was awakened by an angel and shown food on a fire.
1 Chronicles 11:22	Benaiah was noted for his valor.
Psalms 8:3-4	When I observe Your heavens, what is man?
Psalms 24:1	The earth and everything in it belong to the Lord.
Proverbs 25:23	When the north wind blows, the rain would soon be gone.
Isaiah 49:10	Terrific heat of the sun.
Amos 3:5	Snares for birds.
Matthew 8:20	Foxes have dens and birds of the sky have nest
Matthew 17:20	Faith the size of a mustard seed.
Luke 5:16	Jesus often withdrew to a lonely place and prayed.
2 Corinthians 5:17-20	Ministry of reconciliation – We are Ambassadors for Christ

Trip Planning

Exodus 33:11-13	The Lord spoke with Moses face to face.
Deuteronomy 6:4-7	Love the Lord your God with all your heart.
Psalms 119:9-11	How can a young man keep way pure? By treasuring Your word.
Proverbs 1:7	The fear of the Lord is the beginning of wisdom.
Proverbs 15:22	Plans fail without counsel, plans succeed with advisors.
Proverbs 16:3	Commit your activities to the Lord.
Proverbs 19:21	Many plans are in a man's heart, but the Lord's decree will prevail.
Proverbs 21:2	The ways of man seem right to him, but the Lord evaluates.
Jeremiah 6:16	Stand at the crossroads and seek the ancient paths.
Jeremiah 29:11-14	For I know the plans that I have for you.
Jeremiah 33:3	Call to me and I will answer you.
Acts 1:8	You will be My witnesses to the ends of the earth.
Romans 12:1-2	Renew your mind so that you can discern God's will.

Equipment & Shelter

Psalms 23	He lets me lie down in green pastures.
Psalms 55:8	I would hurry to my shelter.
Psalms 119:105	Your word is a lamp to my feet and a light to my path.
Isaiah 25:4	You are a refuge from the storms.
Isaiah 61:10	The Lord has clothed me with His garments.
Matthew 6:33-34	Seek first the kingdom of God and His righteousness.
Matthew 11:28-30	Come to me, all who are weary and burdened.
Matthew 22:37-40	The two greatest commandments.
Matthew 28:18-20	Go into all the world, teaching and making disciples.
Luke 6:46-49	Build your house on the correct foundation.
2 Corinthians 5:1	If our earthly house is destroyed, we have a home in heaven.
Philippians 4:19	My God will supply all your needs.
1 Peter 5:6-7	Cast all your cares on Him, because He cares for you.

Rope Craft

Ecclesiastes 4:12	A cord of three strands is not easily broken.
Luke 1:37	For nothing will be impossible with God.

John 8:31-32 Continue in my word and you will know the truth.
John 10:30 The Father and I are one.
John 15:5 I am the vine; you are the branches.
John 17:9-11 Protect them by Your name so that they may be one.
1 Corinthians 12:12 The body of Christ has many parts.
Philippians 4:13 I can do all things through Him who strengthens me.
Colossians 3:17 Whatever you do in word or deed, do everything in Jesus' name.
1 Timothy 1:12 Give thanks to Christ Jesus because he considered me faithful.

Tool Craft

Proverbs 27:17 Iron sharpens iron, and one man sharpens another.
Ecclesiastes 10:9 The one who splits trees may be endangered by them.
Ecclesiastes 10:10 If the axe is dull you have to exert more strength.
Isaiah 10:15 Does an ax exalt itself above the one who chops with it?
Hebrew 4:12 For the word of God is living and sharper than a knife.

Fire Craft

Proverbs 26:20 Without wood, fire goes out.
Matthew 5:16 Let your light shine before men.
John 3:16 For God so loved the world that He gave His only Son.
Acts 28:3 Paul gathered a bundle of sticks and placed them on the fire.
Hebrews 10:24-25 Lets us be concerned about one another.
Hebrews 12:28-29 For our God is a consuming fire.
1 Peter 1:7 Faith is more valuable than gold that perishes in the fire.

Cooking

Genesis 9:3 God has given every living thing to us as food
Exodus 16:4-5 God supplied bread from heaven.
1 Kings 19:5-8 Elijah was awakened by an angel and shown food on a fire.
2 Kings 4:38-41 Elisha and the poisoned pot of stew.
Luke 13:20-21 Yeast mixed into the flour.
Luke 14:34-35 Salt is good, but if salt should loose its taste.
John 6:5-13 The feeding of 5,000
John 6:35 I am the bread of life.
John 21:9-13 Jesus cooked fish and bread on a bed of coals.
2 Peter 1:3-8 His divine power has given us everything required for life.

First Aid

Isaiah 49:10 The scorching heat or sun will not strike them.
Isaiah 53:5 He was pierced because of our transgressions.
Jeremiah 8:22 Is there no balm in Gilead? Is there no physician there?
Matthew 25:36 I was sick and you took care of me.
Luke 10:30-37 The story of the good Samaritan.
John 19:37 They will look at the one they pierced.
Romans 1:16 I am not ashamed of the gospel, because it is God's salvation.
Galatians 6:9-10 So we must not get tired of doing good.
Philippians 1:6 He who started a good work in you will carry it on to completion.

Safety & Sanitation

Exodus 15:22-25 The Lord showed Moses how to purify the water.
Deuteronomy 23:12-13 Go outside the camp with a spade to relieve yourself.
Job 11:18 You will look carefully about and lie down in safety.
Job 26:14 Who can understand His mighty thunder?
Psalm 4:8 For you alone, Lord, make me live in safety.
Proverbs 29:25 Fear of man is a snare, but those who trust the Lord are protected.
Ephesians 2:8-10 For by grace you are saved through faith.

Map & Compass

Genesis 1:16

God made the stars.

Psalms 25:4-5

Make Your ways known to me, guide me in Your truth.

Psalms 32:8

I will instruct you and show you the way to go.

Psalms 103:12

As far as the east is from the west, he has removed our sins.

Psalms 113:3

From the rising of the sun to its setting, praise the Lord.

Psalms 147:4

He counts the stars and gives names to all of them.

Proverbs 3:5-6

Trust in the Lord and He will guide your path.

Amos 3:3

Can two walk together without agreeing on the direction?

Mark 1:35-39

Jesus got up early and went to a deserted place to pray.

John 14:6

I am the way, the truth and the life.

Hebrews 13:7-8

Remember your leaders who have spoken God's word.

Nature

Genesis 1:20-22

Let us make the living creatures.

Genesis 3:1

Now the serpent was the most cunning of all the wild animals.

Genesis 9:13-17

A rainbow is a reminder of God's promise.

Job 12:7-10

Ask the animals, and they will instruct you.

Job 33:14

God speaks time and again, but a person may not notice it.

Job 39:27-28

The eagle soars and makes its nest up high.

Psalms 8

When I observe Your heavens, what is man?

Psalms 31:3

You are my rock and my fortress.

Psalms 57:10

Your faithfulness reaches to the clouds.

Psalms 69:34

Let heaven and earth praise Him.

Proverbs 25:23

The north wind produces rain.

Isaiah 43:20

God provides water in the wilderness.

Matthew 6:26

Consider the birds of the sky and how God feeds them.

Matthew 6:28-30

God clothes the fields, shall He not do much more for you?

Matthew 10:16

We should be wise as serpents and gentle as doves.

Matthew 13:18-23

Parable of the sower, the seeds and the types of soil.

Mark 13:28-29

The parable of the fig tree.

Romans 1:19-20

From the creation of the world, His divine nature is revealed.

2 Corinthians 5:17

If anyone is in Christ, he is a new creation.

Conservation

Genesis 1:24-25

God created the wildlife.

Genesis 1:26-30

God created man in His likeness to rule over the earth.

Genesis 1:28

God blessed us and gave us responsibility to take care of the world.

Proverbs 27:19

As water reflects the face, so the heart reflects the person.

Ecclesiastes 3:11

He has made everything appropriate in its time.

Matthew 7:12

Whatever you want others to do for you, do also for them.

1 Timothy 2:1-4

Intercede for others, God wants everyone to be saved.

Hebrews 7:25

He is always able to save those who come to God.

Fun & Worship

Psalms 42:1-2

As the deer longs for streams of water, so I long for You, God.

Psalms 66:1

Shout joyfully to God, all the earth!

Zechariah 2:13

Let all the people be silent before the Lord.

Mark 5:18-20

Go back home to your own people and tell them.

Luke 5:16

Yet He often withdrew to deserted places and prayed.

1 Corinthians 15:58

Always give yourself fully to the work of the Lord.

INDEX



A

"A" Frame Tens 33
Aluminum Foil Cooking 109
Axe 75-80

B

Backpacking
 activities 22
 back packs 37
Baking 108
Bees 169
Bible, and Outdoor Living 2
Biking 23
Black Widow Spider 168
Blanket or Envelope Bed 30
Boiling 102
Bowline 55
 double 56
 running 56
Bow Knot 54
Bow Saw 74
Breathing Emergencies 126
Broken Bones 128
Brown Recluse 168
Bruises 128
Buddy Burner and Stove 93
Burns 125
Butterfly Collections 171

C

Campcraft
 Adult 11, 204
 Challenger 8-10, 211-222
 Purpose 5
 RA 6-7, 205-210
Camper's Prayer 200
Camp Worship ideas 199
Camping
 activities 22
Camp Site
 clean and attractive 185
 selection 21
Canoe
 equipment 41
 trip planning 24
 shelters 36
Canteen 81
Can Openers 82
Carrick Bend Knot 53
Casting Animal Tracks 170

Charcoal Fire 94
Checklist for Cooking 120
Chicken Eating Corn
 (Chinese Game) 195
Chiggers 169
Chinese Tag 195
Choking 126
Clothing 28
Clouds 176-178
Clove Hitch 58
Compass
 basic 150
 bearings 152
 degree reading 152
 history 148
 using 154
 simple 149
Conducting Flag Ceremonies 201
Conservation 183-190
 and You 185
 Pledge 184
 Projects 189
Continuous Lashing 67
Cooking 99-120
 devices 117
 methods 102
 tips 118
Copperhead 167
Coral Snake 167
Cottonmouth Moccasin 167
Cow Hitch 59
Criss-Cross Fire 90
Cuts and Scratches 124
Cycles of Nature 164

D

Deadman Anchors 35
Devotional Ideas 199
 nature and God 179-182
Degree Reading 152
Diagonal Lashing 65
Direction, finding 156
Dish Washing 143
Distance measurement 156
Dome Tents 33
Double Half Hitch 58
Dragon's Tail 193
Drinking Water Safety 137
Drowning 132
Dutch Oven Cooking 112-116

E

Elbow Tag 194
Emergency Action Steps 122
End Securing Knots 58
End Splice 63
Envelope Sleeping Bag 30
Equipment and Shelter 25-42
 shelters 36
 tips 42
 tents 32
Eye Splice 64

F

Fainting 125
Fire Ants 169
Fire
 conservation 186
 putting out a 92, 187
 safety 87, 137
 starters 89
 types 90-91
Firecraft 85-98
Fire Site
 leave no trace 88
 preparing 87
Firewood, gathering 88
First Aid 121-132
 Kits 122
Fisherman's Knot 52
Foilburgers 110
Folding Saw 74
Food List 120
Food Storage 144
Forecasting Weather 173
Free Standing Tents 33
Frying 104
Fuel 88, 95-96
Fun and worship 191-200
Frost Bite 131

G

Games Leading 192
 global 195
 nature 172
Garbage
 disposal 144
Global Positioning Systems 162
God
 through nature 179-182
Good Neighbor Policy 185

Granny Knot 52
Grilling 105
Griddle 107
Group
 equipment 29
 nature activities 172

H

Hammer 82
Heatstroke 125
Hiker's Fire 91
Hiking
 activities 22
 safety 134
 song 197
Hitch
 clove 58
 cow 59
 half 58
 taut-line 57
 timber 59
 trucker 60
Hornets 169
Human Waste Disposal 145
Hunter's Fire 91
Hygiene
 personal 27, 142
Hypothermia 131, 138

I

Ice Packs 130
Insect Bites 130

J

Joiner Knots 51
Journal 22, 24

K

Keyhole Fire 91
Kindling 88
Knot board 69
 tying 49
Know Your Trees 170
Knives 72

L

Lashing 64

Latrines 145
Leading Games 192
Leading Songs 197
Leadership Responsibilities 20
Leave No Trace 146
Lightning 140-141
Leaf Prints 170
Limb a Tree 78
Log, of Trip 22, 24
Long Splice 62
Loop Knots 55
Lost, What to Do 135

M

Man Harness Knot 57
Man, Tiger and Gun Game 196
Map and Compass 147-162
Maps
 orientation 159
 scale 159
 symbols 159
 topographical 158
Matches 86
Meal Planner 119
Meal in Foil 110-111
Measurement 156
Menu Planning 100-102
Missions
 application 14
 stories 198
Mosquitoes 130, 169

N

Nature 163-182
 activities 172-173
 collection 170
 devotional ideas 179-182
 cycles 164
Nosebleeds 128

O

Ohayo-Konichiwa
 Japanese game 195
Oriental
 self portraits 196
Orienting
 the map 159
 your compass 151
Outdoor Manners 185

Overhand Knot 50

P

Packs
 expedition frame 37
 day packs 37
 how to pack 38-39
 frames packs 37
 putting on 40
 youth frame 37
 using 41
Patches
 adult 11
 Challenger 8
 Royal Ambassador 6
Pebble Game 196
Personal
 equipment and clothing 26
 hygiene 27, 142
 washing 142
Planning
 evaluation 24
 group 16-19
 trip 22-24
Plants
 conservation 188
 cooking 118
 poisonous if eaten 165
 poisonous if touched 166
Plaster
 cast tracks 170
Pocket Knife 72
Poison
 internal 132
 ivy 129, 166
 oak 129, 166
 snake bite 129
 sumac 129, 166
Poisonous
 plants 165-166
 snakes 167
Poncho as a Tent 36
Primitive Camping
 activities 22
Pup Tents 33

R

Rain Fly Shelters 36
Rattlesnakes 167
Reef Knot 51
Reflector Fire 90-91

Rescue
 breathing 127
 drowning 132
Ropecraft 43-70
Rope Machine 70
Round Lashing 66
RA Campcraft
 Discoverer 1 205
 Discoverer 2 206
 Discoverer 3 207
 Hiker Checklist 208
 Camper Checklist 209
 Woodsman Checklist 210
 Pathfinder 211
 Adventurer 215
 Backpacker 217
 Trip Camper 219
 Primitive Camper 221

S

Safety and Sanitation 133-146
 drinking water 137
 fire 137
 hiking 134
 storage 144
 tools 137
 weather 138
Saws 74
Sawbuck 75
Scorpions 169
Sealed Orders 199
Severe Bleeding 128
Severe Weather 140
Sharing God
 through nature 179-181
Sharpening
 axe 76
 pocket knife 72
 sheath knife 74
Sheath Knife 74
Sheepshank 60
Sheet Bend Knot 53
Shelters, tips 36, 42
Shock 125
Shopping Guide
 food 120
Short Splice 62
Signs
 trail 148
 weather 175
Sighting Point
 compass 152
Sit Down 135

Sleeping Bags 31
Slip Knot 60
Snacks, Trail 117
Snake Bites 129
Soil Conservation 187
Solo Tents 33
Songs 197-198
Splicing 61
Spiders 168
Spider Web
 collecting 172
Spit Cooking 106
Spiritual Applications 13
Spiritual Markers 113, 223
Splint Bones 128
Splinters 124
Splitting Wood 78-80
Sprains 128
Square
 knot 51
 lashing 64
Stand Up 193
Stars as Direction 156
Steal the Bacon 194
Stepping Measurement 156
Stewardship
 of God's Word 12
Stop 135
Stopped Breathing 127
Stopper Knots 50
Storage 144
Stories 198
Stoves
 backpacking 96
 camp 95
 choosing 97
Strains 128
Stroke 132
Summer Clothing 28
Sun as Direction 157
Surgeon's Knot 52
Survival Kits 136
Survival Skills 136

T

Tarp Shelters 36
Taut-line Hitch 57
Tents 32-35
Tepee Fire 90
Ticks 169
Tiller's Knot 55
Timber Hitch 59
Tinder 88

Tips on
 cooking 118
 equipment and shelter 42
 firecraft 98
 trip planning 22
Toasting 105
Toilet Tag 194
Tool Craft 71-84
 apron 84
 other 81
 safety 137
 storage roll 83
Topographical Maps 158
Tracks
 plaster 170
Trail Signs 148
Tree
 conservation 189
 display 170
 poisonous 165
Trench Fire 91
Trim Saw 74
Trip Camping
 activities 22
Trip Log 22, 24
Trip Planning 15
Tripod Lashing 65
Two Half Hitches 56

U

Using a Pack 41

W

Wall Tents 33
Wash Stand 142
Washing Dishes 143
Wasp 169
Water
 conservation 187
 pollution 189
 purification 137
Weather Forecasting 173
Weather Indicators 174
Weather Sayings 173
Whipping Ropes 48
Wildlife Conservation 188
Winter
 camping 32
 clothing 25
Wood Fires 86
Wood Ticks 169
Worship 192

Sharing Your Personal Christian Experience

To witness, literally, means to tell what you have seen or heard from first-hand experience. When witnessing, you are sharing your personal experience and relationship with Jesus Christ. This is called sharing your personal testimony. Your testimony will explain how you personally talk with Jesus through prayer, what it feels like to have the Holy Spirit working inside you, how Jesus speaks to you, how He helps you in everyday life, what it means to give Him control of your life, and how you value His friendship and guidance.

To develop your own personal testimony, use the following simple outline.

- Before – What your life was like before you accepted Christ.
- How – How you received Christ.
- After – What your life is like after receiving Christ.

Every Christian has a testimony and every testimony is special. After all, it is yours and nobody else's. Have you shared your testimony lately?

Sharing the Message of Christ

As a leader you will have the opportunity to share with boys and young men what it means to be a Christian. Every leader needs to become aware of age-appropriate ways they can share the message of Christ. Children and youth are inquisitive creatures by nature, and they will inquire about what it means to be a Christian and what they have to do to become a Christian.



Leaders need to exercise prayer and great care in the matter of sharing answers concerning spiritual matters. Our role is that of seed planters, allowing the Holy Spirit to water the seeds of faith. We are called to lift Jesus Christ up and allow Him to draw all men unto Himself. We need to become spiritually sensitive to the activity of God, and not hinder the children from coming to Him. Knowing that the invitation never ends for those whom the Father draws to Christ, it is important to be able to tell how you came to know Christ personally. Developing a personal relationship with a child provides the best opportunity to share this witness in a meaningful way.

